

Sidekick 10" Compound Slide Saw

(Models 36-240 and 36-250)



Bench Model 36-240 Shown

PART NO. 902096 (014)
Copyright © 2001 Delta Machinery

INSTRUCTION MANUAL



To learn more about DELTA MACHINERY
visit our website at: www.deltamachinery.com.

For Parts, Service, Warranty or other Assistance,

please call **1-800-223-7278** (In Canada call **1-800-463-3582**).

ESPAÑOL: PÁGINA 33

SAFETY RULES

Woodworking can be dangerous if safe and proper operating procedures are not followed. As with all machinery, there are certain hazards involved with the operation of the product. Using the machine with respect and caution will considerably lessen the possibility of personal injury. However, if normal safety precautions are overlooked or ignored, personal injury to the operator may result. Safety equipment such as guards, push sticks, hold-downs, featherboards, goggles, dust masks and hearing protection can reduce your potential for injury. But even the best guard won't make up for poor judgment, carelessness or inattention. Always use common sense and exercise caution in the workshop. If a procedure feels dangerous, don't try it. Figure out an alternative procedure that feels safer. **REMEMBER:** Your personal safety is your responsibility.

This machine was designed for certain applications only. Delta Machinery strongly recommends that this machine not be modified and/or used for any application other than that for which it was designed. If you have any questions relative to a particular application, **DO NOT** use the machine until you have first contacted Delta to determine if it can or should be performed on the product.

**Technical Service Manager
Delta Machinery
4825 Highway 45 North
Jackson, TN 38305**

(IN CANADA: 505 SOUTHGATE DRIVE, GUELPH, ONTARIO N1H 6M7)



WARNING: FAILURE TO FOLLOW THESE RULES MAY RESULT IN SERIOUS PERSONAL INJURY

1. **FOR YOUR OWN SAFETY, READ INSTRUCTION MANUAL BEFORE OPERATING THE TOOL.** Learn the tool's application and limitations as well as the specific hazards peculiar to it.

2. **KEEP GUARDS IN PLACE** and in working order.

3. **ALWAYS WEAR EYE PROTECTION.**

4. **REMOVE ADJUSTING KEYS AND WRENCHES.** Form habit of checking to see that keys and adjusting wrenches are removed from tool before turning it "on".

5. **KEEP WORK AREA CLEAN.** Cluttered areas and benches invite accidents.

6. **DON'T USE IN DANGEROUS ENVIRONMENT.** Don't use power tools in damp or wet locations, or expose them to rain. Keep work area well-lighted.

7. **KEEP CHILDREN AND VISITORS AWAY.** All children and visitors should be kept a safe distance from work area.

8. **MAKE WORKSHOP CHILDPROOF** – with padlocks, master switches, or by removing starter keys.

9. **DON'T FORCE TOOL.** It will do the job better and be safer at the rate for which it was designed.

10. **USE RIGHT TOOL.** Don't force tool or attachment to do a job for which it was not designed.

11. **WEAR PROPER APPAREL.** No loose clothing, gloves, neckties, rings, bracelets, or other jewelry to get caught in moving parts. Nonslip footwear is recommended. Wear protective hair covering to contain long hair.

12. **ALWAYS USE SAFETY GLASSES.** Wear safety glasses. Everyday eyeglasses only have impact resistant lenses; they are not safety glasses. Also use face or dust mask if cutting operation is dusty. These safety glasses must conform to ANSI Z87.1 requirements. Note: Approved glasses have Z87 printed or stamped on them.

13. **SECURE WORK.** Use clamps or a vise to hold work when practical. It's safer than using your hand and frees both hands to operate tool.

14. **DON'T OVERREACH.** Keep proper footing and balance at all times.

15. **MAINTAIN TOOLS IN TOP CONDITION.** Keep tools sharp and clean for best and safest performance. Follow instructions for lubricating and changing accessories.

16. **DISCONNECT TOOLS** before servicing and when changing accessories such as blades, bits, cutters, etc.

17. **USE RECOMMENDED ACCESSORIES.** The use of accessories and attachments not recommended by Delta may cause hazards or risk of injury to persons.

18. **REDUCE THE RISK OF UNINTENTIONAL STARTING.** Make sure switch is in "OFF" position before plugging in power cord. In the event of a power failure, move switch to the "OFF" position.

19. **NEVER STAND ON TOOL.** Serious injury could occur if the tool is tipped or if the cutting tool is accidentally contacted.

20. **CHECK DAMAGED PARTS.** Before further use of the tool, a guard or other part that is damaged should be carefully checked to ensure that it will operate properly and perform its intended function – check for alignment of moving parts, binding of moving parts, breakage of parts, mounting, and any other conditions that may affect its operation. A guard or other part that is damaged should be properly repaired or replaced.

21. **DIRECTION OF FEED.** Feed work into a blade or cutter against the direction of rotation of the blade or cutter only.

22. **NEVER LEAVE TOOL RUNNING UNATTENDED. TURN POWER OFF.** Don't leave tool until it comes to a complete stop.

23. **DRUGS, ALCOHOL, MEDICATION.** Do not operate tool while under the influence of drugs, alcohol or any medication.

24. **MAKE SURE TOOL IS DISCONNECTED FROM POWER SUPPLY** while motor is being mounted, connected or re-connected.

25. **THE DUST GENERATED** by certain woods and wood products can be injurious to your health. Always operate machinery in well ventilated areas and provide for proper dust removal. Use wood dust collection systems whenever possible.

26.  **WARNING: SOME DUST CREATED BY POWER SANDING, SAWING, GRINDING, DRILLING, AND OTHER CONSTRUCTION ACTIVITIES** contains chemicals known to cause cancer, birth defects or other reproductive harm. Some examples of these chemicals are:

- lead from lead-based paints,
- crystalline silica from bricks and cement and other masonry products, and
- arsenic and chromium from chemically-treated lumber.

Your risk from these exposures varies, depending on how often you do this type of work. To reduce your exposure to these chemicals: work in a well ventilated area, and work with approved safety equipment, such as those dust masks that are specially designed to filter out microscopic particles.

SAVE THESE INSTRUCTIONS. Refer to them often and use them to instruct others.

ADDITIONAL SAFETY RULES FOR COMPOUND SLIDE SAWS

1. **USE ONLY CROSSCUT SAW BLADES. WHEN USING CARBIDE TIPPED BLADES MAKE SURE THEY HAVE A ZERO DEGREE OR NEGATIVE HOOK ANGLE. DO NOT USE BLADES WITH DEEP GULLETS AS THEY CAN DEFLECT AND CONTACT GUARD.**
2. **DO NOT** operate the tool until it is completely assembled and installed according to the instructions.
3. **IF YOU ARE NOT** thoroughly familiar with the operation of compound slide saws, obtain advice from your supervisor, instructor or other qualified person.
4. **SLIDE CUTTING BY PULLING** the saw towards the operator can be dangerous, causing the saw to kick upwards and towards the operator. Always **PUSH** the saw forward, away from the operator, and towards the fence when slide cutting.
5. **WHEN USING THE SAW AS A MITER SAW AND MAKING CHOP CUTS, MAKE SURE** the saw sliding mechanism is locked in place to prevent the saw from kicking towards the operator.
6. **BE CAREFUL** when folding or unfolding legs. Pivot points are also pinch points.
7. **PLACE** stand on flat and level surface.
8. **MAKE CERTAIN** that extension work supports are properly locked in place before operating tool.
9. **DO NOT** stand on work table or use support extension as a ladder or scaffolding.
10. **MAXIMUM** workpiece weight limitation – 50 lbs. per table extension.
11. **NEVER PLACE YOUR HANDS INSIDE** the area designated as a hazard zone while the tool is being operated.
12. **ALWAYS** hold the work firmly against the fence and table. **DO NOT** perform any operation free hand.
13. **IMPORTANT:** If the workpiece you are cutting causes your hand to be within 4 inches of the saw blade, the workpiece must be clamped to the table before cutting.
14. **BE SURE** blade is sharp, runs freely and is free of vibration.
15. **ALLOW** the motor to come up to full speed before starting cut.
16. **KEEP** the motor air slots clean and free of chips.
17. **ALWAYS MAKE SURE** all clamp handles are tight before cutting.
18. **BE SURE** blade and blade flanges are clean and that arbor screw is tightened securely.
19. **USE** only blade flanges specified for your saw.
20. **NEVER** use blades larger or smaller in diameter than recommended. Recommended size of blade is 10" in diameter.
21. **NEVER** apply lubricants to the blade while it is running.
22. **ALWAYS** check the blade for cracks or damage before operation. Replace cracked or damaged blade immediately.
23. **USE ONLY** blades rated for operation of at least 5000 RPM.
24. **ONLY** use blades with 5/8" diameter arbor holes.
25. **USE** the blade guard at all times.
26. **ALWAYS** keep the lower blade guard in place and operating properly.
27. **ALWAYS** keep hands out of path of saw blade.
28. **NEVER** reach around saw blade.
29. **MAKE SURE** blade is not contacting workpiece before switch is turned on.
30. **NEVER** lock the switch in the "ON" position.
31. **IMPORTANT:** After completing cut, release power switch and wait for coasting blade to stop before returning saw to raised position.
32. **THE USE** of attachments and accessories not recommended by Delta may result in the risk of injuries.
33. **TURN OFF** tool and make sure blade has come to a complete stop before removing or securing workpiece, changing workpiece angle or changing the angle of the blade.
34. **NEVER** cut ferrous metals or masonry.
35. **NEVER** recut small pieces.
36. **PROVIDE** adequate support to the sides of the saw table for long workpieces.
37. **NEVER** use the tool in an area with flammable liquids or gases.
38. **NEVER** use solvents to clean plastic parts. Solvents could possibly dissolve or otherwise damage the material. Only a soft, damp cloth should be used to clean plastic parts.
39. **DISCONNECT** tool from power source before servicing or changing blades.

(continued next page)

40. **DISCONNECT** tool from power source and clean the machine before leaving it.
41. **IMPORTANT: When the tool is not in use, the switch should be locked in the “OFF” position to prevent unauthorized use.**
42. **MAKE SURE** the work area is cleaned before leaving the machine.
43. **SHOULD** any part of your tool be missing, damaged, or fail in any way, or any electrical component fail to perform properly, shut off switch and remove plug from power supply outlet. Replace missing, damaged or failed parts before resuming operation.
44. **ADDITIONAL INFORMATION** regarding the safe and proper operation of this product is available from the National Safety Council, 1121 Spring Lake Drive, Itasca, IL 60143-3201, in the Accident Prevention Manual for Industrial Operations and also in the Safety Data Sheets provided by the NSC. Please also refer to the American National Standards Institute ANSI 01.1 Safety Requirements for Woodworking Machinery and the U.S. Department of Labor OSHA 1910.213 Regulations.

CONNECTING TOOL TO POWER SOURCE

POWER CONNECTIONS

A separate electrical circuit should be used for your tools. This circuit should not be less than #12 wire and should be protected with a 20 Amp time lag fuse. If an extension cord is used, use only 3-wire extension cords which have 3-prong grounding type plugs and 3-hole receptacles which accept the tool's plug. Before connecting the motor to the power line, make sure the switch is in the “OFF” position and be sure that the electric current is of the same characteristics as indicated on the tool. All line connections should make good contact. Running on low voltage will damage the motor.

 **WARNING: DO NOT EXPOSE THE TOOL TO RAIN OR OPERATE THE TOOL IN DAMP LOCATIONS.**

MOTOR SPECIFICATIONS

Your tool is wired for 120 volt, 60 HZ alternating current. Before connecting the tool to the power source, make sure the switch is in the “OFF” position. The no-load speed of the motor is 5000 RPM.

GROUNDING INSTRUCTIONS

 **WARNING: THIS TOOL MUST BE GROUNDED WHILE IN USE TO PROTECT THE OPERATOR FROM ELECTRIC SHOCK.**

1. All grounded, cord-connected tools: In the event of a malfunction or breakdown, grounding provides a path of least resistance for electric current to reduce the risk of electric shock. This tool is equipped with an electric cord having an equipment-grounding conductor and a grounding plug. The plug must be plugged into a matching outlet that is properly installed and grounded in accordance with all local codes and ordinances.

Do not modify the plug provided - if it will not fit the outlet, have the proper outlet installed by a qualified electrician.

Improper connection of the equipment-grounding conductor can result in risk of electric shock. The conductor with insulation having an outer surface that is green with or without yellow stripes is the equipment-grounding conductor. If repair or replacement of the electric cord or plug is necessary, do not connect the equipment-grounding conductor to a live terminal.

Check with a qualified electrician or service personnel if the grounding instructions are not completely understood, or if in doubt as to whether the tool is properly grounded.

Use only 3-wire extension cords that have 3-prong grounding type plugs and 3-hole receptacles that accept the tool's plug, as shown in Fig. AA.

Repair or replace damaged or worn cord immediately.

2. Grounded, cord-connected tools intended for use on a supply circuit having a nominal rating less than 150 volts:

This tool is intended for use on a circuit that has an outlet that looks like the one illustrated in Fig. AA. The tool has a grounding plug that looks like the plug illustrated in Fig. AA. A temporary adapter, which looks like the adapter illustrated in Fig. BB, may be used to connect this plug to a 2-hole receptacle as shown in Fig. BB if a properly grounded outlet is not available. The temporary adapter should be used only until a properly grounded outlet can be installed by a qualified electrician. The green-colored rigid ear, lug, and the like, extending from the adapter must be connected to a permanent ground such as a properly grounded outlet box. Whenever the adapter is used, it must be held in place with a metal screw.

NOTE: In Canada, the use of a temporary adapter is not permitted by the Canadian Electric Code.

 **WARNING: IN ALL CASES, MAKE CERTAIN THE RECEPTACLE IN QUESTION IS PROPERLY GROUNDED. IF YOU ARE NOT SURE HAVE A QUALIFIED ELECTRICIAN CHECK THE RECEPTACLE.**

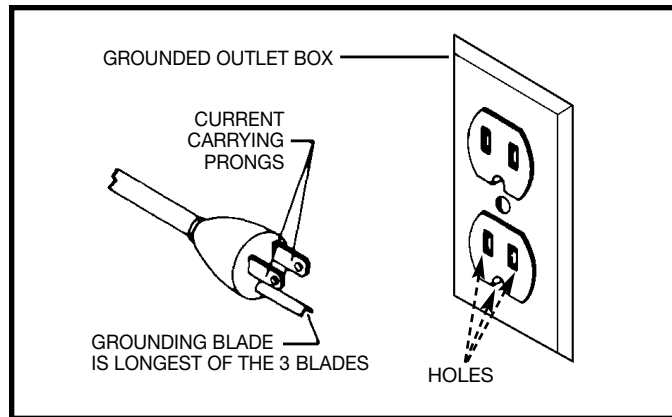

Fig. AA

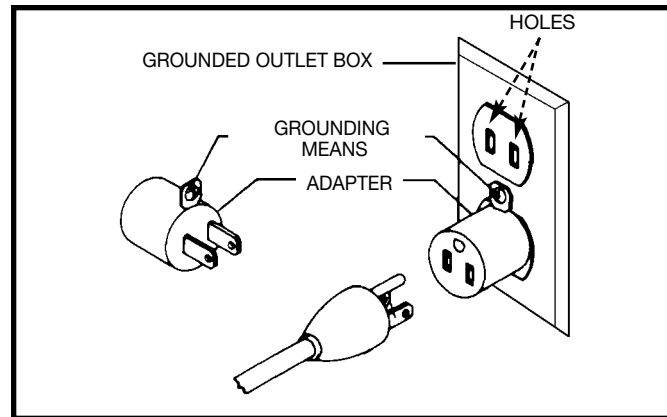

Fig. BB

EXTENSION CORDS

Use proper extension cords. Make sure your extension cord is in good condition and is a 3-wire extension cord which has a 3-prong grounding type plug and a 3-hole receptacle which will accept the tool's plug. When using an extension cord, be sure to use one heavy enough to carry the current of the tool. An undersized cord will cause a drop in line voltage, resulting in loss of power and overheating. Fig. DD, shows the correct gauge to use depending on the cord length. If in doubt, use the next heavier gauge. The smaller the gauge number, the heavier the cord.

MINIMUM GAUGE EXTENSION CORD			
RECOMMENDED SIZES FOR USE WITH STATIONARY ELECTRIC TOOLS			
Ampere Rating	Volts	Total Length of Cord in Feet	Gauge of Extension Cord
0-6	120	up to 25	18 AWG
0-6	120	25-50	16 AWG
0-6	120	50-100	16 AWG
0-6	120	100-150	14 AWG
6-10	120	up to 25	18 AWG
6-10	120	25-50	16 AWG
6-10	120	50-100	14 AWG
6-10	120	100-150	12 AWG
10-12	120	up to 25	16 AWG
10-12	120	25-50	16 AWG
10-12	120	50-100	14 AWG
10-12	120	100-150	12 AWG
12-16	120	up to 25	14 AWG
12-16	120	25-50	12 AWG
12-16	120	GREATER THAN 50 FEET NOT RECOMMENDED	

Fig. DD

OPERATING INSTRUCTIONS

FOREWORD

Delta Model 36-240/250 is a 10" Sliding Compound Miter Saw designed to cut wood. It can cut material up to 11¹/₂" at 90° and 8" at 45° miter. The depth of cut is 3⁵/₈" at 90° and 2" at 45°. bevel. It has positive miter stops at 0°, 22.5°, 31.62°, and 45° degrees both left and right, and positive bevel stops at 0° and 45° left. It also includes the following features; D-handle design with trigger switch for positive control, electric brake automatically stops blade in seconds, automatic retracting see-thru blade guard, built-in arbor lock for easy single wrench blade changes, dust bag, built-in left and right table extensions with stock stops, fence, table insert, stand, extra-long 10' cord and carbide tipped blade.

UNPACKING AND CLEANING

Your Sliding Compound Miter Saw is shipped in one carton. Carefully remove the machine and all loose items from the shipping container. Remove the protective coating from all unpainted parts. This coating may be removed with a soft cloth moistened with kerosene (do not use acetone, gasoline, or lacquer thinner for this purpose). After cleaning, cover the unpainted surfaces with a good quality household floor paste wax. Figs. 2 and 3 illustrate the slide saw models removed from the shipping carton. Fig. 4 illustrates the loose items supplied with your machine. **IMPORTANT:** Do not remove the cable tie (A) Figs. 2 and 3 that is holding the cuttinghead in the down position until the machine is placed on a workbench or the stand model has been set in an upright position.

NOTICE: THE MANUAL COVER PHOTO ILLUSTRATES THE CURRENT PRODUCTION MODEL. ALL OTHER ILLUSTRATIONS ARE REPRESENTATIVE ONLY AND MAY NOT DEPICT THE ACTUAL COLOR, LABELING OR ACCESSORIES.

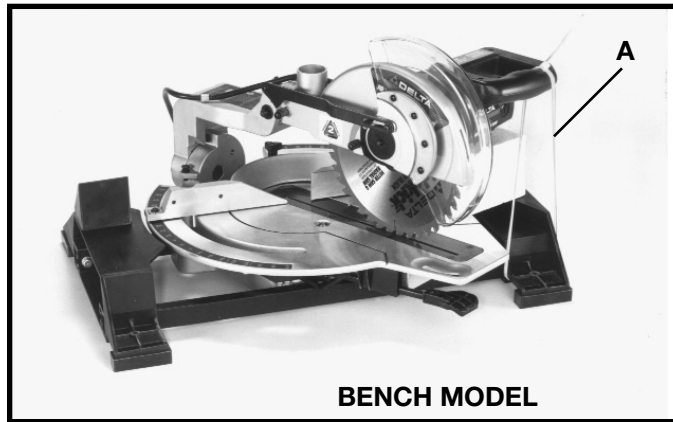

Fig. 2

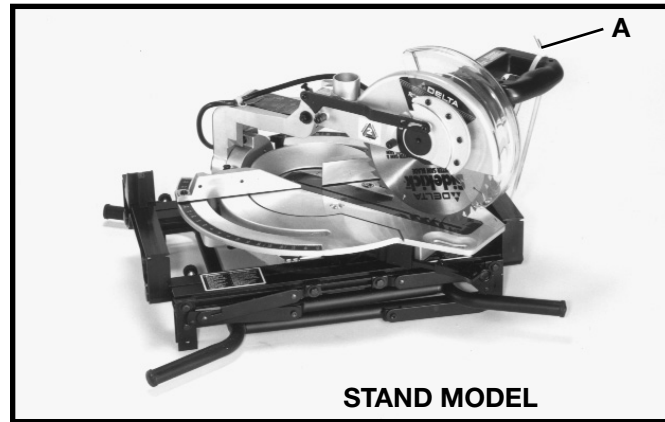

Fig. 3

CAUTION: DO NOT LIFT THE MACHINE BY THE OPERATING HANDLE.

1. Dust elbow
2. Work clamp
3. Bevel locking knob
4. Flat washer
5. Dust bag
6. Four mounting feet
(furnished with stand models only)

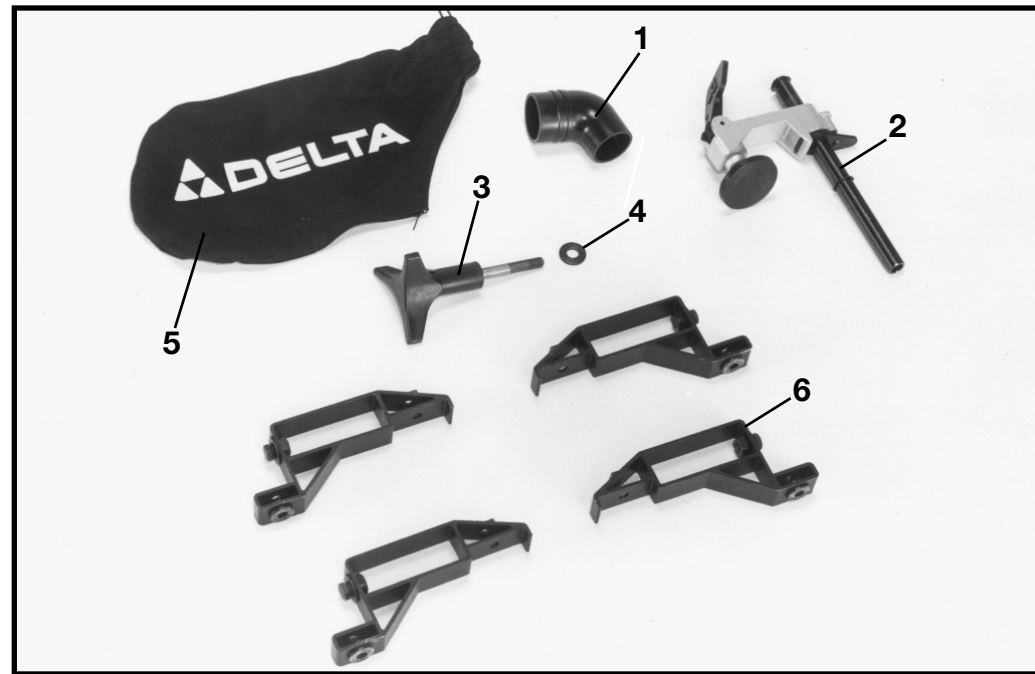

Fig. 4

ASSEMBLY

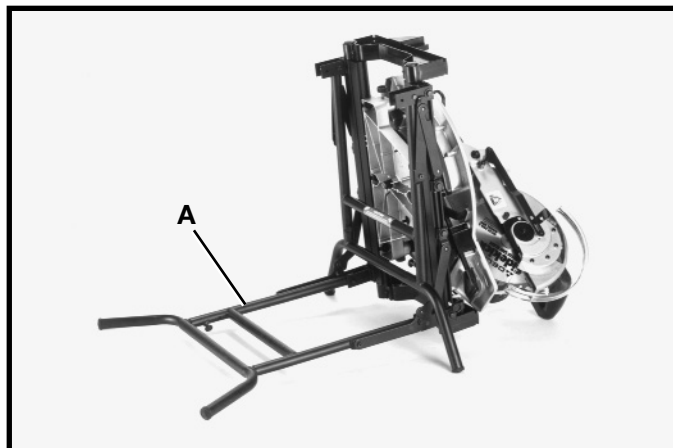

Fig. 5

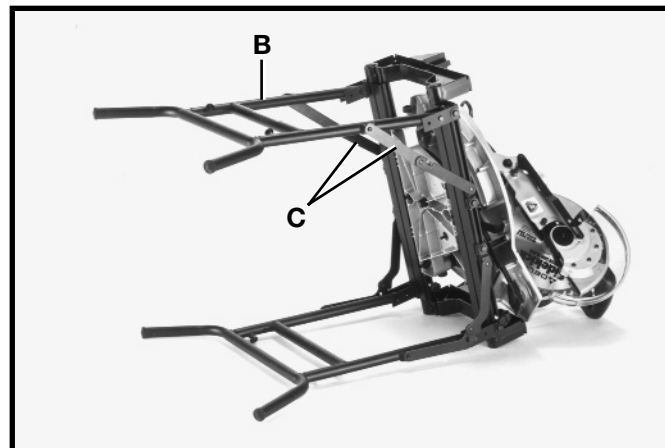

Fig. 6

SETTING UP STAND (For Model 36-250 Only)

1. Tilt the machine on its right side and unfold right leg (A) as shown in Fig. 5.
2. Lift up and unfold left leg (B) Fig. 6, and lock in place by pushing inward on leg hinges (C).

3. Pivot the machine so feet (D) Fig. 7, of the left leg are on the floor. **NOTE:** Make certain the leg hinges (C) Fig. 7, are locked in place before raising the machine to an upright position.

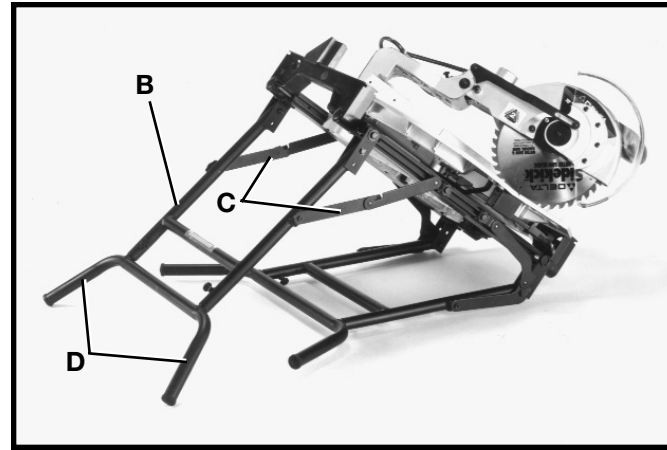

Fig. 7

4. Raise the right side of the machine and unfold right leg (A) Fig. 8. Lock right leg (A) in position by pushing hinges (E) inward.

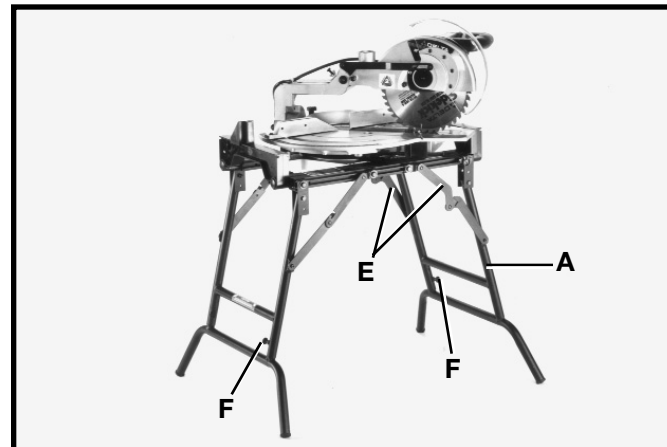

Fig. 8

5. Loosen four lock knobs on leg assemblies, two of which are shown at (F) Fig. 8.

6. With foot on lower brace (G) Fig. 9, lift up table extension (H) so upper leg (J) extends out from lower leg (K) and protrusions (L) Fig. 10, snap in and engage with round holes in upper legs (J). This locks the upper and lower legs (J) and (K) in position. Tighten two locking knobs (F) Fig. 10.

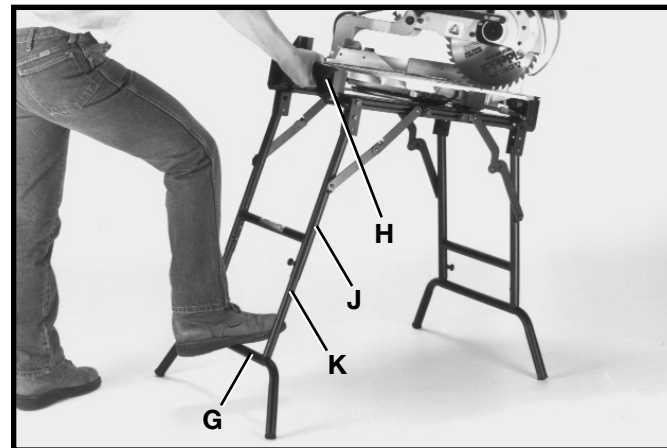

Fig. 9

7. Pull right side upper leg (L) Fig. 11, from lower leg (K) in the same manner. Tighten the remaining two locking knobs (F). **CAUTION:** Make certain both legs are fully extended and locked in position before operating the saw.

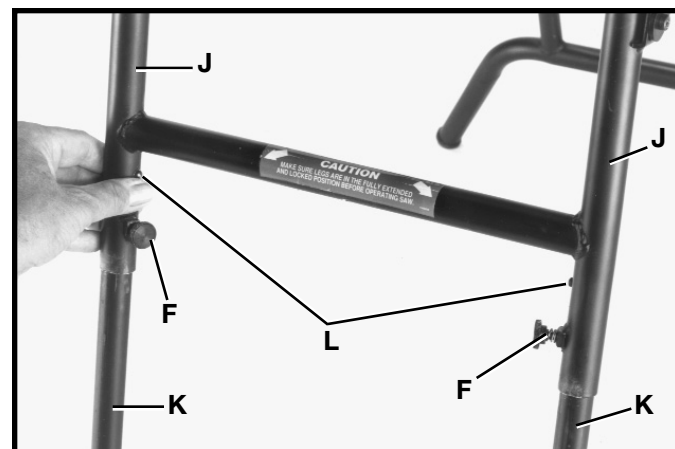

Fig. 10

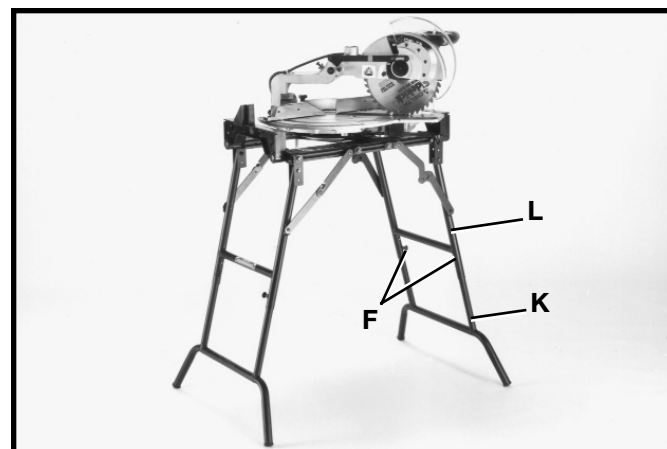

Fig. 11

MOVING CUTTINGHEAD TO THE REAR POSITION (For models 36-240 and 36-250)

1. **MAKE CERTAIN THE TOOL IS DISCONNECTED FROM THE POWER SOURCE.**

2. Carefully remove cable tie (A) Fig. 12, which is holding the cuttinghead in the down position.

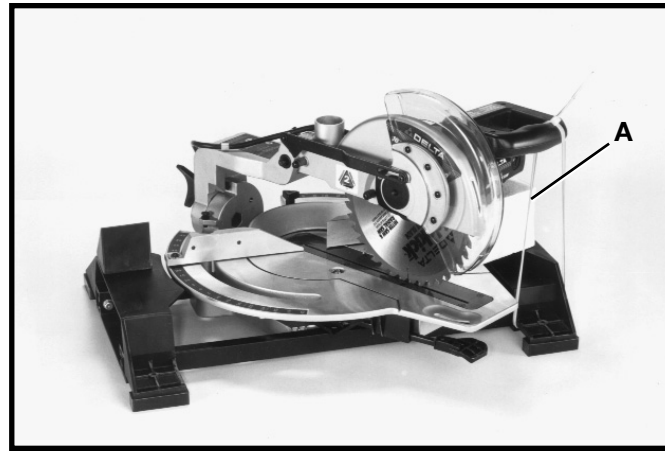

Fig. 12

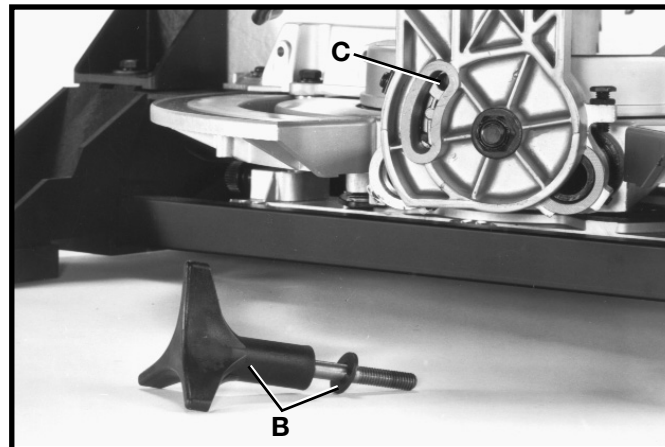

Fig. 13

3. Find the bevel locking knob with flat washer (B) Fig. 13, supplied with the machine. Thread bevel locking knob and flat washer into hole (C) Fig. 13. Assembled bevel locking knob is shown in (B) Fig. 14. Firmly tighten locking knob.

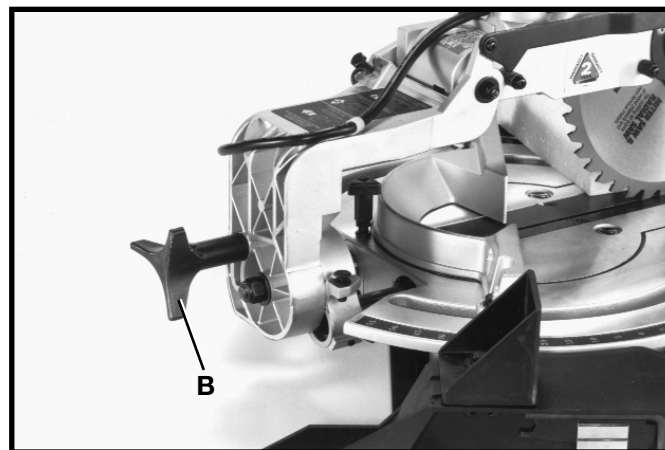

Fig. 14

4. To move the cuttinghead (D) Fig. 15, to the rear position, loosen lock knob (E) and push cuttinghead (D) to the rear position. Then tighten lock knob (E) Fig. 16.

5. Fig. 16, illustrates the cuttinghead locked in the rear position.

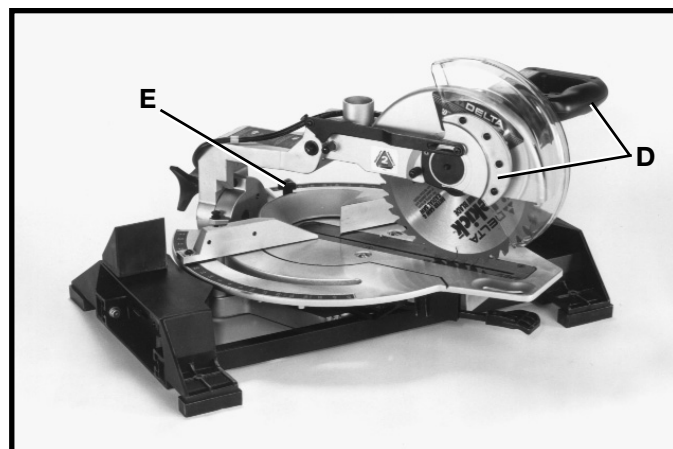

Fig. 15

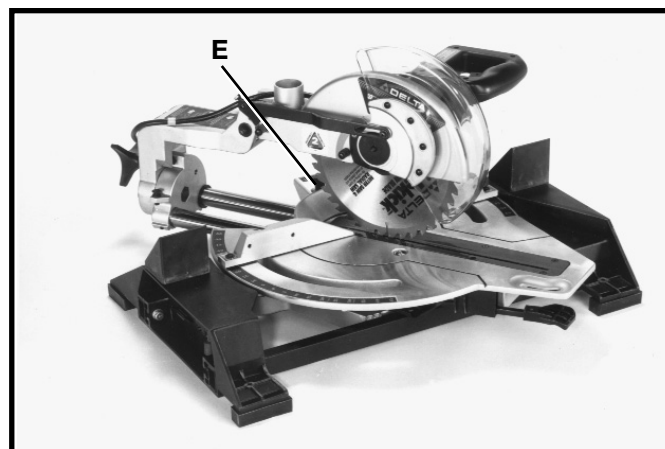

Fig. 16

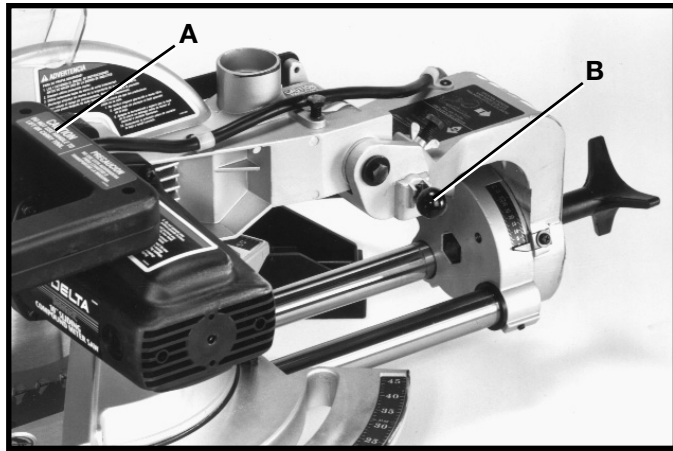

Fig. 17

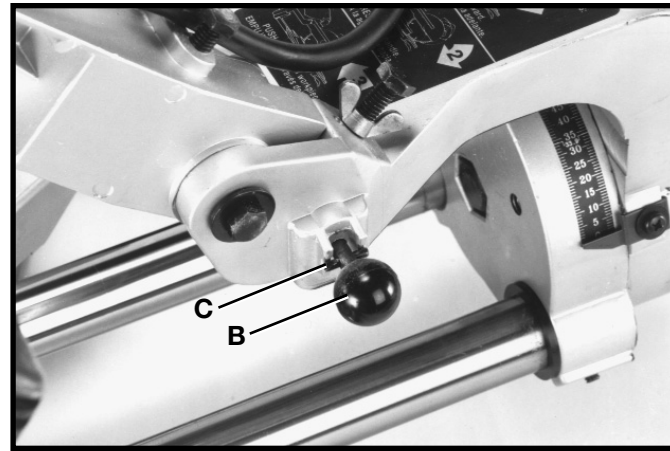

Fig. 18

RAISING THE CUTTINGHEAD

1. While holding the cuttinghead (A) Fig. 17, down, pull out and rotate cuttinghead lock knob (B) 90 degrees until pin (C) Fig. 18, is in the horizontal position as shown. The cuttinghead can then be raised.
2. Fig. 19, illustrates the cuttinghead (A) in the raised position.

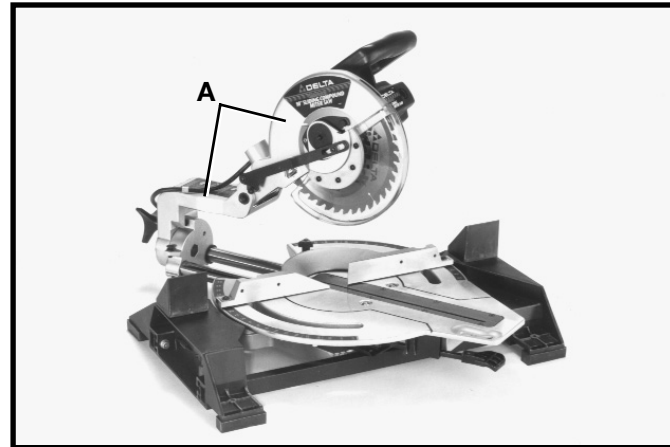

Fig. 19

ASSEMBLING DUST ELBOW AND DUST BAG

1. Insert smooth end of dust elbow (A) Fig. 20, into opening (B). The dust elbow (A) can be rotated as desired.
2. Compress spring clips (C) Fig. 21, on dust bag (D) and clip dust bag onto end of elbow (A) as shown.

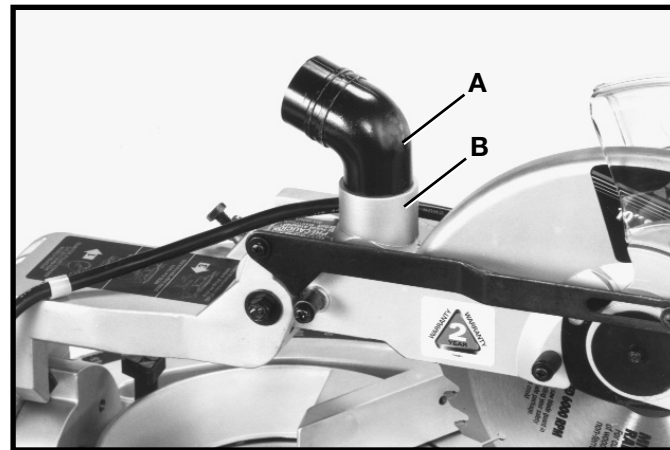

Fig. 20

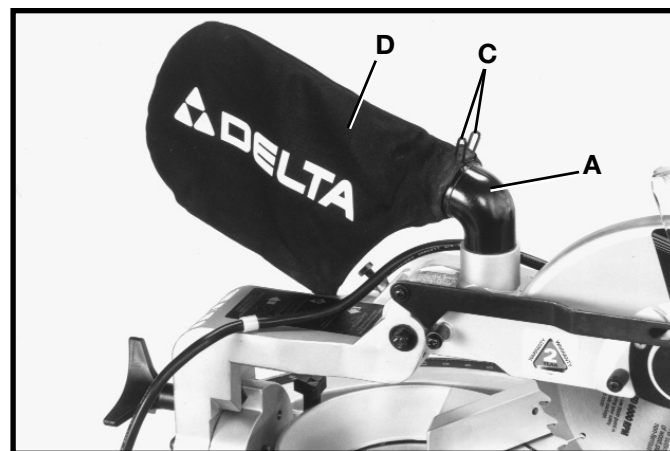

Fig. 21

MOVING TABLE TO THE 90 DEGREE CUT-OFF POSITION

1. Compress table locking lever (A) Fig. 22, and rotate table (B) to the straight 90 degree cut-off position. Release locking lever (A).

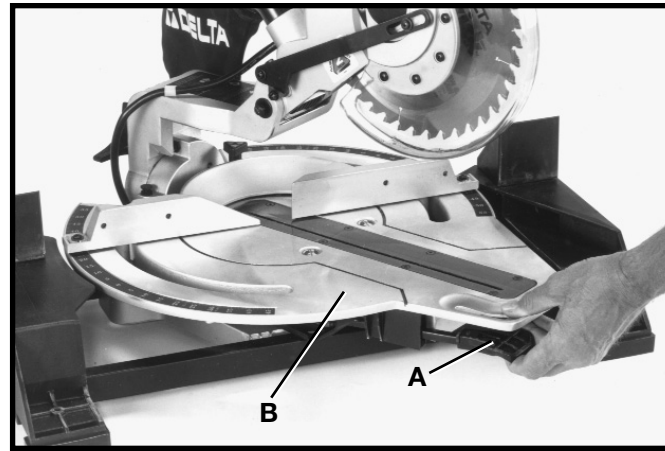

Fig. 22

2. Fig. 23, illustrates the table (B) locked in the straight 90 degree cut-off position. **NOTE:** Table locking lever (A) must be compressed when rotating table. When releasing lever (A) Fig. 23, the table is in the locked position.

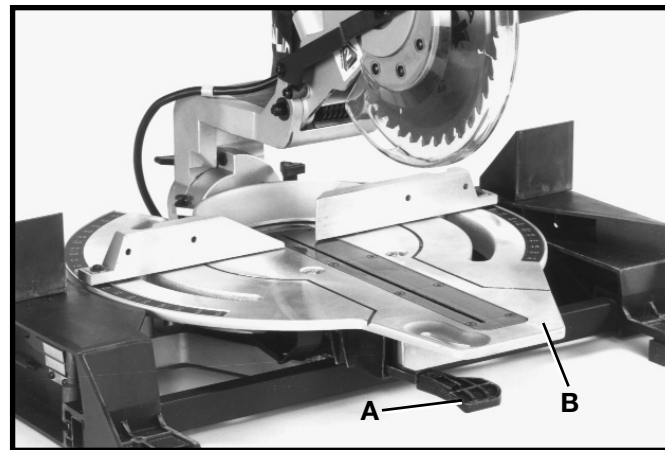

Fig. 23

3. For proper operation and adjustment of the table, refer to sections “**ROTATING TABLE FOR MITER CUTTING**”, “**ADJUSTING CLAMPING ACTION OF TABLE LOCKING MECHANISM**” and “**ADJUSTING SLIDING FIT BETWEEN MOVABLE TABLE AND BASE.**”

ASSEMBLING WORK CLAMP

1. Insert post (A) Fig. 24, of work clamp assembly (B) down through hole in the base of the machine as shown and lock in place by tightening lock knob (C). The work clamp (B) Fig. 24, can be used on the right or left side of the cuttinghead.

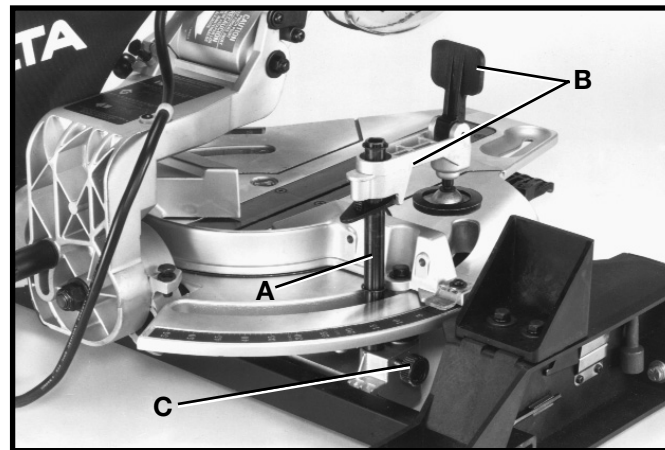

Fig. 24

2. For proper operation of the work clamp, refer to section “**WORK CLAMP OPERATION.**”

OPERATING CONTROLS AND ADJUSTMENTS

STARTING AND STOPPING MACHINE

To start the machine, compress switch trigger (A) Fig. 28. To stop the machine, release the switch trigger.

This tool is equipped with an automatic electric blade brake. As soon as the switch trigger (A) Fig. 28 is released, the electric brake is activated and stops the blade in seconds.

⚠ DANGER: A TURNING SAW BLADE CAN BE DANGEROUS. AFTER COMPLETING CUT, RELEASE SWITCH TRIGGER (A) FIG. 28, TO ACTIVATE BLADE BRAKE. KEEP CUTTINGHEAD DOWN UNTIL BLADE HAS COME TO A COMPLETE STOP.

⚠ WARNING: THE TORQUE DEVELOPED DURING BRAKING MAY LOOSEN THE ARBOR SCREW. THE ARBOR SCREW SHOULD BE CHECKED PERIODICALLY AND TIGHTENED IF NECESSARY.

LOCKING SWITCH IN THE “OFF” POSITION

IMPORTANT: When the tool is not in use, the switch should be locked in the “OFF” position (to prevent unauthorized use) using a padlock (B), with a 3/16” shank, as shown in Fig. 29. Padlock is available from Delta as an accessory.



Fig. 28

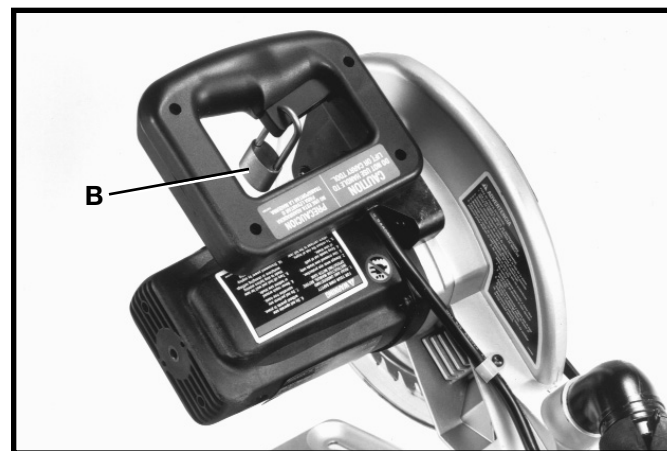

Fig. 29

ROTATING TABLE FOR MITER CUTTING

1. Your compound slide saw will cut any angle from a straight 90 degree cut to 57 degrees to the right and 47 degrees to the left. Compress table locking lever (A) Fig. 30, and move the table to the desired angle. Then release table locking lever (A).

2. **IMPORTANT:** Table locking lever (A) Fig. 30, must be compressed when rotating the table. When locking lever (A) is not compressed, the table is in the locked position.

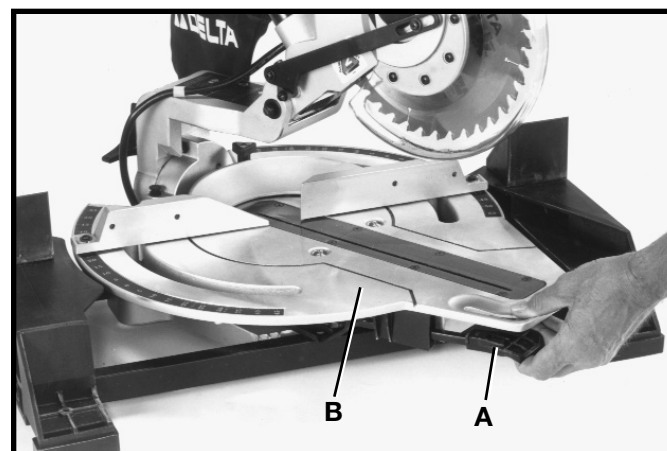

Fig. 30



Fig. 31

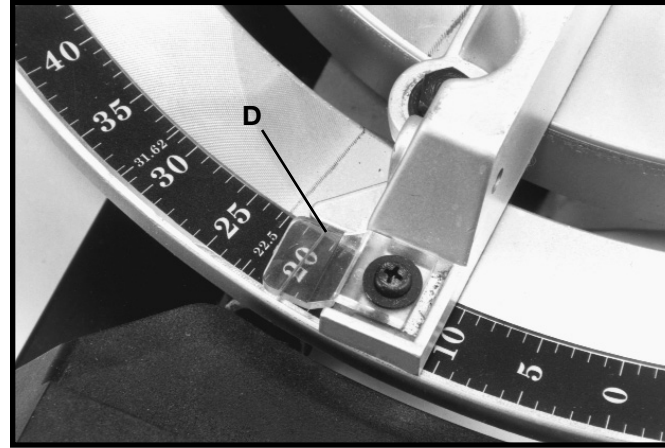

Fig. 32

3. The compound slide saw is equipped with spring-loaded positive stops at the 90 degree straight cut-off position and at the 15, 22.5, 31.62 and 45 degrees right and left miter positions. These spring-loaded positive stops can be felt as you are rotating the table. **NOTE:** The 31.62 degree right and left miter positive stops are used when cutting crown moulding as explained later in this manual. Two large scales, one of which is shown at (C) Fig. 31, are provided on each end of the table and two cursors, one of which is shown at (D) Fig. 32, are provided for intermediate angles.

ADJUSTING CLAMPING ACTION OF TABLE LOCKING MECHANISM

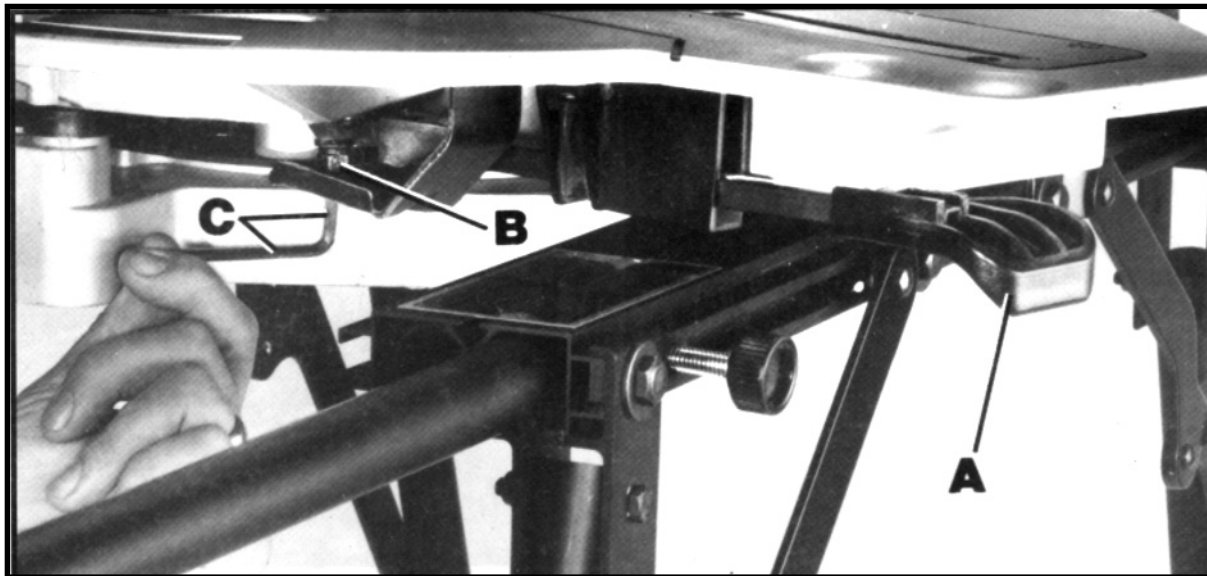

Fig. 33

When rotating the table, the table locking lever (A) Fig. 33, must be compressed. When the locking lever (A) is not compressed, the table should be in the locked position. When the clamping action of the table locking mechanism needs adjusting, proceed as follows:

1. Move the table to the 22.5 degree left miter angle.
2. Loosen locknut (B) Fig. 33, using the open end wrench supplied, and turn screw with allen wrench (C) supplied. Turn screw clockwise to increase or counterclockwise to decrease clamping action of locking lever (A). **IMPORTANT: After adjustment is completed, tighten locknut (B), just enough to take all play out of the handle assembly. Tightening locknut (B) too much will defeat the purpose of the adjustment.**

ADJUSTING SLIDING FIT BETWEEN MOVABLE TABLE AND BASE

When it becomes necessary to adjust the sliding fit between the movable table and the base proceed as follows: Turn nut (A) Fig. 34, clockwise to increase or counterclockwise to decrease the sliding fit. This adjustment should not be too tight that it restricts the rotating movement of the table or too loose that it affects the accuracy of the saw.

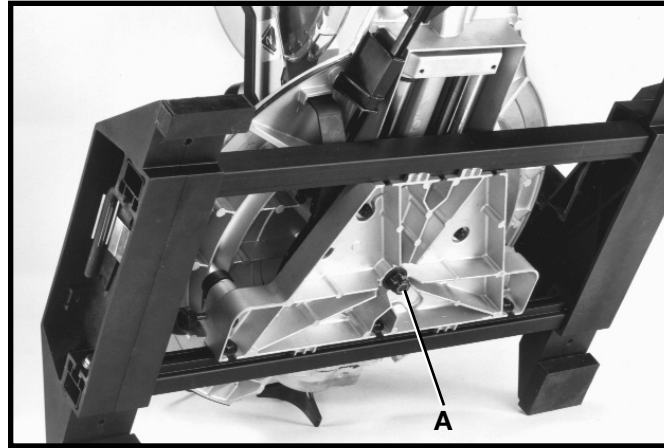

Fig. 34

ADJUSTING FENCE 90 DEGREES TO BLADE

IMPORTANT: BEFORE MAKING THIS ADJUSTMENT, MAKE CERTAIN THE BLADE IS SET AT 90 DEGREES TO THE TABLE. SEE SECTION "ADJUSTING 90 AND 45 DEGREE BEVEL POSITIVE STOPS."

1. **DISCONNECT THE TOOL FROM THE POWER SOURCE.**

2. Rotate the table so that the blade is 90 degrees to the fence and the spring-loaded positive stop for the 0 degree mark on the scale is engaged.

3. Using a square (A) Fig. 35, place one end of the square against the fence (B) and the other end against the blade as shown. Check to see if the fence is 90 degrees to the blade.

4. If an adjustment is necessary, the fence (B) can be adjusted by loosening the two screws, one of which is shown at (C) Fig. 35, that attach the fence to the base, using wrench (D) supplied. Adjust the fence (B) as required and tighten two screws (C).

5. After you are sure the fence is 90 degrees to the blade, adjust the two cursors, one of which is shown at (E) Fig. 36, so the pointer is aligned with the 0 degree mark on the scale by loosening screw (F), adjusting cursor (E) and tightening screw (F).

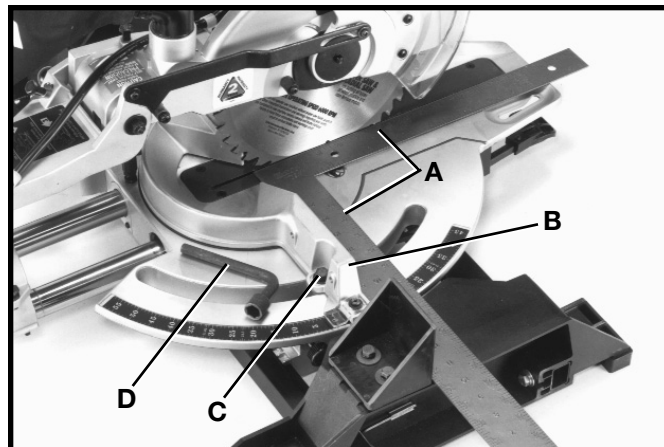

Fig. 35

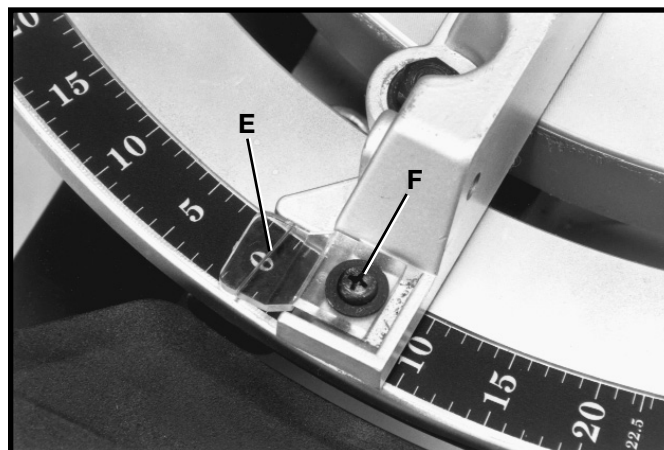

Fig. 36

TABLE HAZARD AREA

⚠ WARNING: THE AREA INSIDE THE RED LINE (A) FIG. 37, ON THE TABLE IS DESIGNATED AS A HAZARD ZONE. NEVER PLACE YOUR HANDS INSIDE THIS AREA WHILE THE TOOL IS BEING OPERATED.

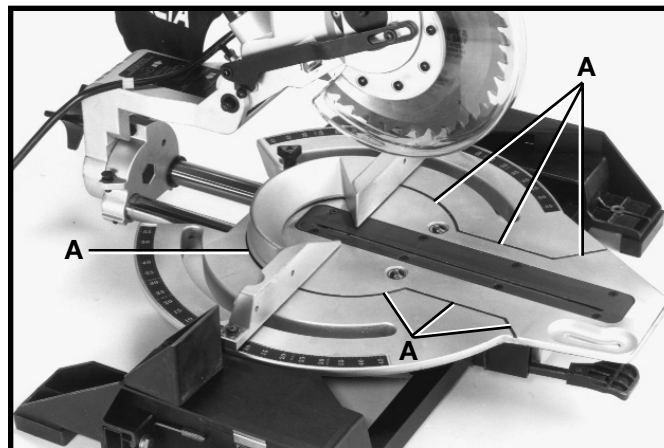

Fig. 37

WORK CLAMP OPERATION

1. The height of the work clamp (A) Fig. 38, can be adjusted by loosening lock knob (B) and moving post (C) up or down, or compressing lock lever (D) and sliding clamp body (E) up or down. After height of clamp (A) is adjusted, tighten lock knob (B) and/or release lock lever (D).

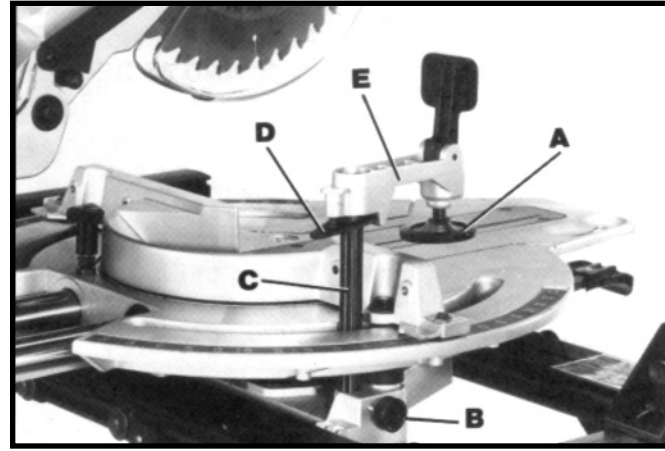

Fig. 38

2. During operation, lower clamp (A) Fig. 39, until the bottom of the clamp (A) lightly contacts top of workpiece (F). **IMPORTANT: When lowering clamp (A) make certain cam lever (G) is in the up position as shown.**

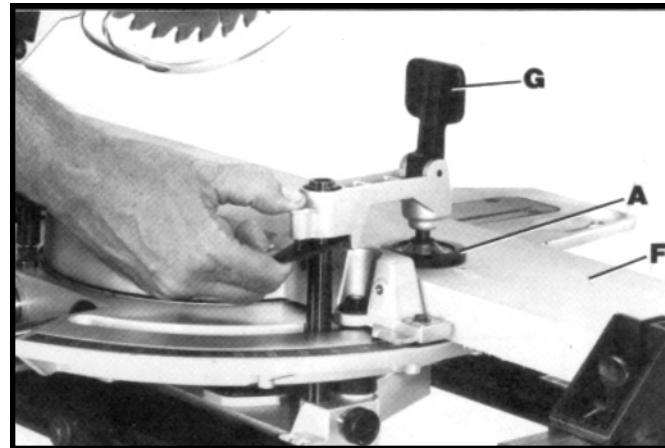

Fig. 39

3. For final clamping of the workpiece (F) Fig. 40, against the table, move cam lever (G) to the rear, as shown. After cut is completed, lift lever (G). This will raise clamp (A) slightly, allowing you to slide or remove workpiece (F).

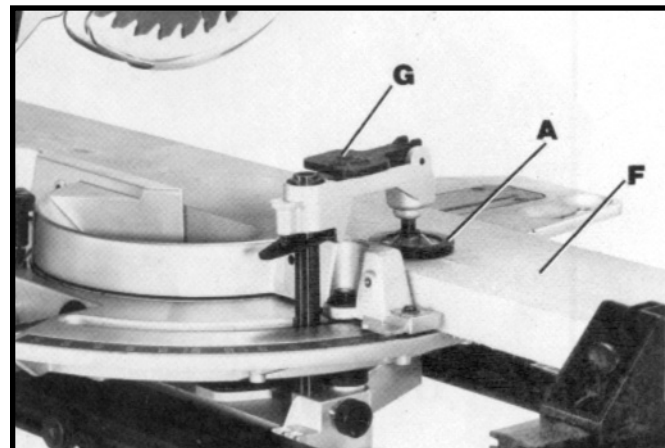

Fig. 40

TILTING CUTTINGHEAD FOR BEVEL CUTTING

The cuttinghead of your compound slide saw can be tilted to cut any bevel angle from a 90 degree straight cut-off to a 45 degree left bevel angle by loosening bevel lock knob (A) Fig. 41, tilting cuttinghead (B) to the desired angle, and tightening lock knob (A).

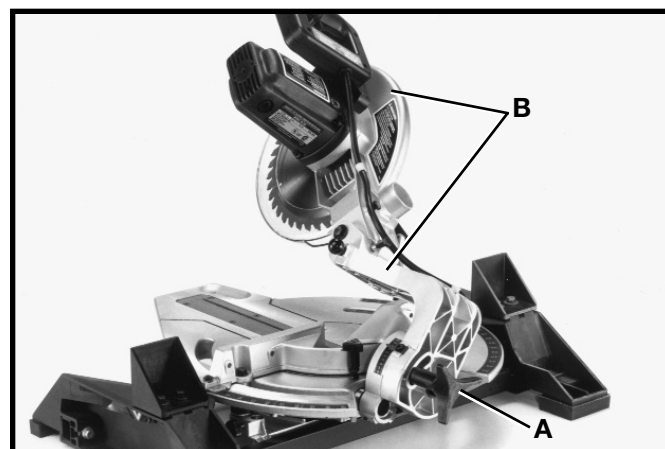

Fig. 41

Positive stops are provided to rapidly position the saw blade at 90 and 45 degrees to the table. Refer to the section of this manual titled “**ADJUSTING 90 AND 45 DEGREE BEVEL STOPS.**” The bevel angle of the cutting arm is determined by the position of the pointer (C) Fig. 42, on scale (D).

In addition, an indicator is provided on the bevel scale at the 33.9 degree bevel angle for cutting crown moulding. Refer to the “**CUTTING CROWN MOULDING**” section of this manual.

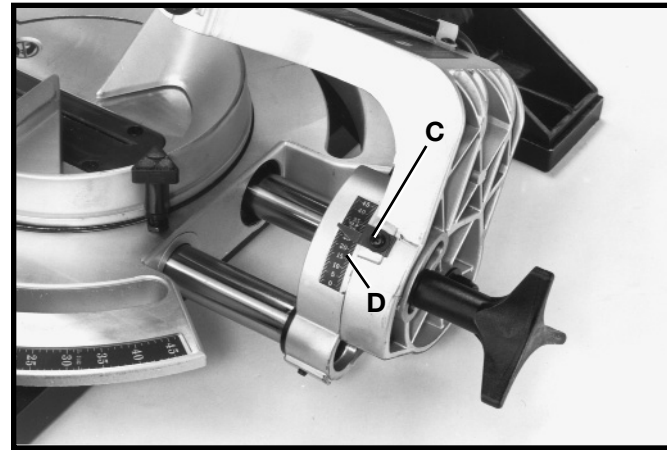

Fig. 42

ADJUSTING SLIDING FIT BETWEEN TRUNNION AND BEVEL BRACKET

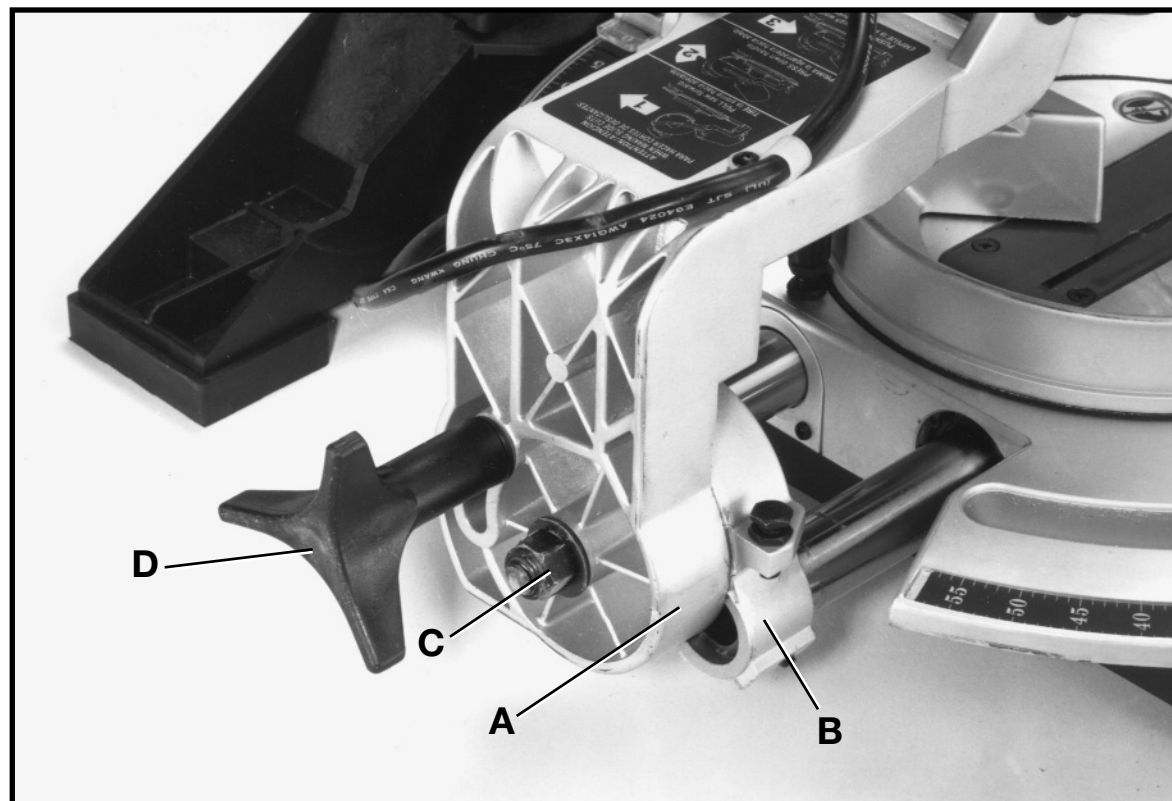

Fig. 43

When it becomes necessary to adjust the sliding fit between the trunnion (A) Fig. 43, and bevel bracket (B), proceed as follows: Tighten adjusting nut (C) until snug sliding fit is obtained. **NOTE:** This adjustment must be made with the bevel lock handle (D) loose. This adjustment should not be too tight that it restricts the sliding movement or too loose that it affects the accuracy of the saw cut.

ADJUSTING 90 AND 45 DEGREE BEVEL POSITIVE STOPS

1. **DISCONNECT THE TOOL FROM THE POWER SOURCE.**

2. Loosen bevel lock handle and move the cuttinghead all the way to the right. Then tighten bevel lock handle.

3. Using a square (A) Fig. 44, place one end of the square on the table and the other end against the blade, as shown. Check to see if the blade is at 90 degrees to the table.



Fig. 44

4. If an adjustment is necessary, loosen bevel lock handle. Then loosen locknut (B) Fig. 45, and turn adjusting screw (C) until head of screw (C) contacts inside of casting (D) when blade is 90 degrees to the table. Then tighten locknut (B).

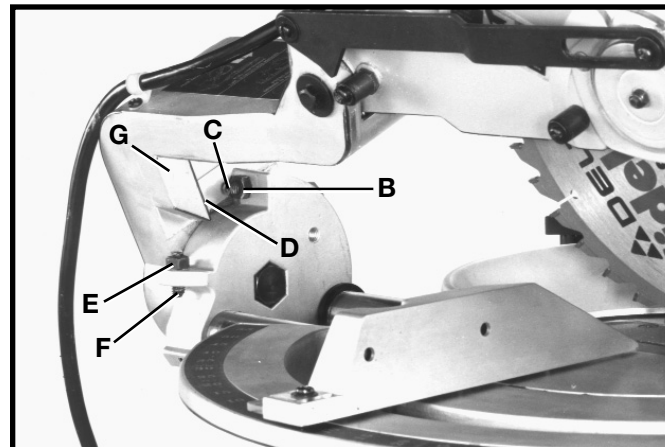

Fig. 45

5. When you are certain blade is 90 degrees to table, loosen screw (J) Fig. 46, and adjust pointer (H) to line up with the 0 degree mark on bevel scale (K).

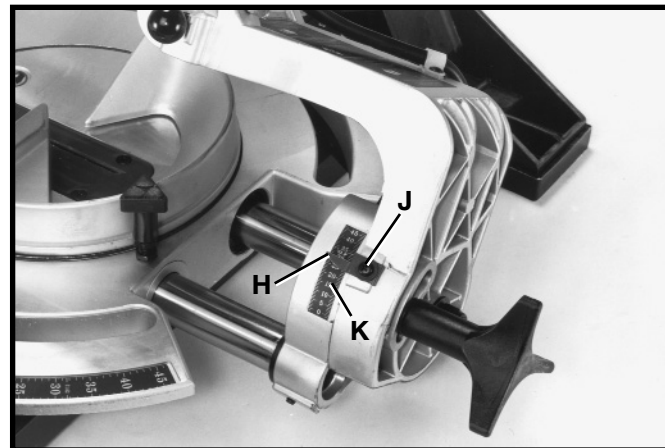

Fig. 46

6. Loosen bevel lock handle and move cuttinghead all the way to the left bevel position and tighten bevel lock handle.

7. Using a square (A) Fig. 47, check to see if the blade is at 45 degrees to the table, as shown.

8. If an adjustment is necessary, loosen bevel lock handle. Then loosen locknut (E) Fig. 45, and turn adjusting screw (F) until head of screw (F) contacts surface (G) when blade is 45 degrees to the table. Then tighten locknut (E).

9. These positive stops enable you to rapidly position the blade at the most common bevel angles to the table, 90 and 45 degrees.



Fig. 47

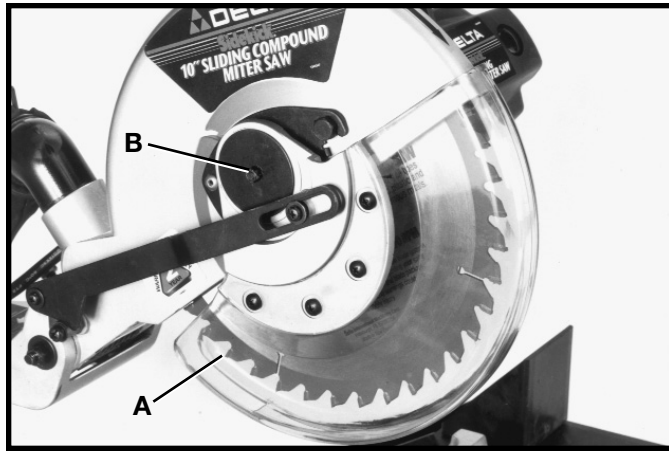

Fig. 48

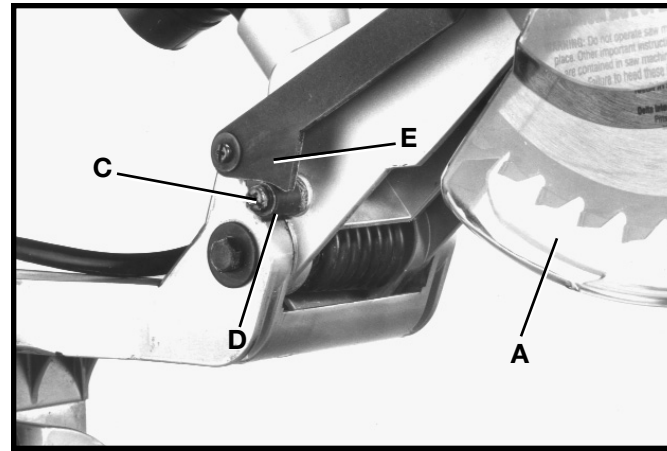

Fig. 49

ADJUSTING BLADE GUARD

1. The movable blade guard (A) Fig. 48, can be adjusted for proper movement as follows: Tighten nut (B) until the lower blade guard (A) moves smoothly as the cuttinghead is lowered.
2. As soon as the cuttinghead begins to lower, the lower blade guard (A) Fig. 49, should begin to move. If it does not, loosen screw (C) and rotate eccentric (D) so that the eccentric (D) is contacting the actuating arm (E) when the cuttinghead is in the top position. Then tighten screw (C).

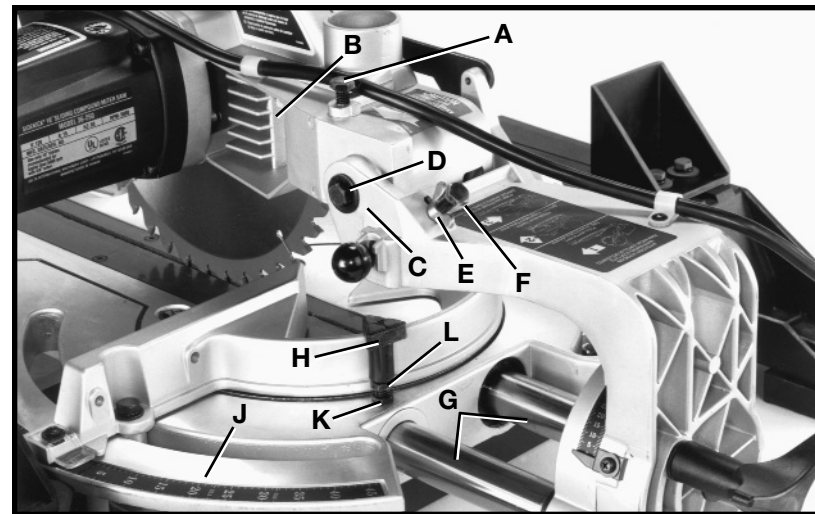

Fig. 50

ADJUSTING TENSION OF CUTTINGHEAD RETURN SPRING

The tension of the cuttinghead return spring has been adjusted at the factory in order that the cuttinghead returns to the up position after a cut has been made. If it ever becomes necessary to re-adjust the spring tension, proceed as follows:

1. Turn adjusting screw (A) Fig. 50, clockwise to increase or counterclockwise to decrease the spring tension.

ADJUSTING SLIDING FIT BETWEEN UPPER ARM AND TRUNNION

When it becomes necessary to adjust the sliding fit proceed as follows: The fit between the upper arm (B) Fig. 50, and the trunnion (C) can be adjusted by tightening nut (D). Correct adjustment is when a good, snug sliding fit is obtained between these two parts. This adjustment should not be too tight that it restricts the sliding movement of the upper arm (B), or too loose that it affects the accuracy of the saw cut.

ADJUSTING DOWNWARD TRAVEL OF SAW BLADE

The downward travel of the saw blade was adjusted at the factory to prevent the saw blade from contacting any metal surfaces of the machine. When an adjustment becomes necessary to limit the downward travel of the saw blade, proceed as follows: Loosen wing nut (E) Fig. 50, and make adjustment by turning adjusting screw (F). Tighten wing nut (E) after adjustment is completed. (for operations such as dado cutting see section of manual on “**DADO CUTTING**”)

LOCKING CUTTINGHEAD GUIDE RODS

The cuttinghead guide rods (G) Fig. 50, can be locked in place in order to use the saw as a conventional miter saw (using the saw as a chop saw instead of a sliding saw) by tightening lock knob (H). When using the saw as a chop saw, the cuttinghead should be all the way to the rear position before locking in place.

ADJUSTING SLIDING FIT BETWEEN GUIDE RODS AND TABLE ASSEMBLY

To adjust the sliding fit between guide rods (G) Fig. 50, and table assembly (J), remove lock knob (H) and loosen locknut (K). With wrenches provided, hold locknut (K) while turning adjusting nut (L) clockwise to increase or counterclockwise to decrease the sliding action of the guide rods (G). This adjustment should not be too tight that it restricts the sliding movement of the rods or too loose that it affects the accuracy of the saw cut. When correct adjustment is made, hold adjusting nut (L) and tighten locknut (K) with wrenches provided. Replace lock knob (H). Periodically lubricate guide rods (G) using a light oil or spray lubricant to keep the guide rods (G) sliding smoothly.

TOOL STORAGE

Clips are supplied in the left side of saw table extension which provides a convenient storage area for the three wrenches (A) Fig. 51. These wrenches are used for various adjustments to the compound slide saw. **NOTE:** Storage area is located on the right hand side on Model 36-250.

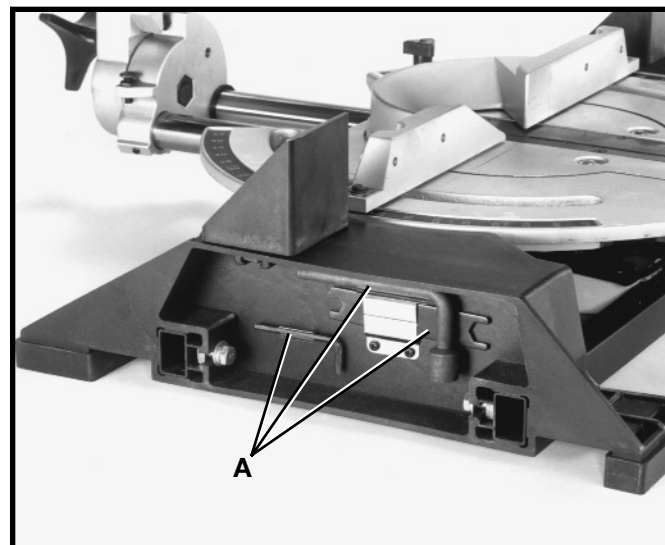

Fig. 51

ADJUSTING TABLE EXTENSIONS AND AUXILIARY FENCES

(FOR MODEL 36-250 ONLY)

Table extensions, one of which is shown at (A) Fig. 52, are provided on each end of the saw stand to support extra long workpieces. To move the table extensions, loosen the two lock screws (B), pull out table extension (A) to desired position and tighten lock screws (B). The top surface of the table extension (A) is slightly lower than the saw table and adequately supports just about any size of workpiece that fits into the saw.

An auxiliary fence (C) Fig. 53, is provided on each table extension and should be adjusted in line with the saw fence (E) by loosening screw (D) and sliding auxiliary fence (C) until it contacts the workpiece as shown.

NOTE: MAXIMUM LOAD PER EACH TABLE EXTENSION IS 50 POUNDS.

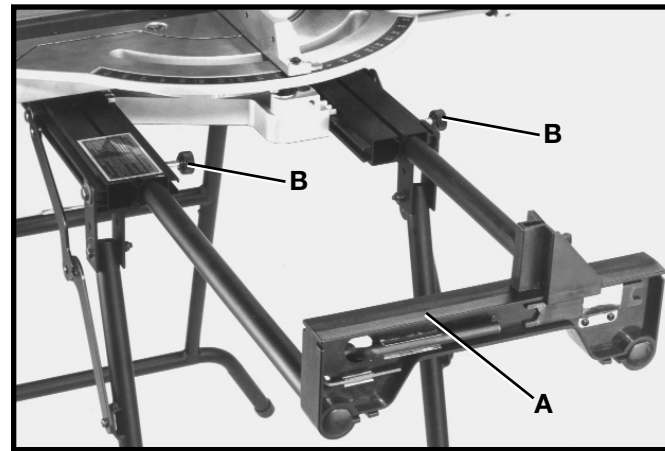

Fig. 52

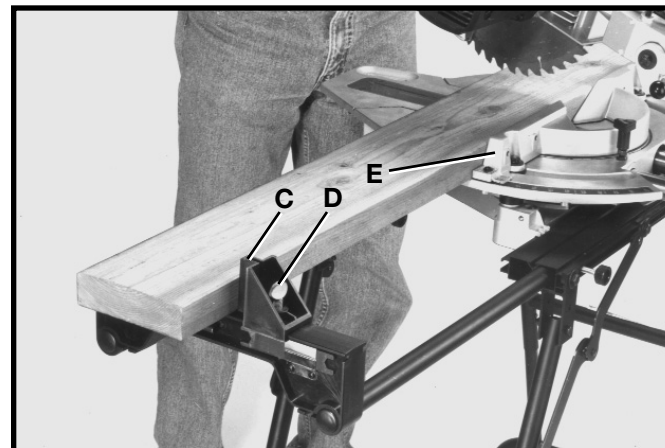

Fig. 53

USING AUXILIARY FENCE AS A STOCK STOP

(FOR MODEL 36-250 ONLY)

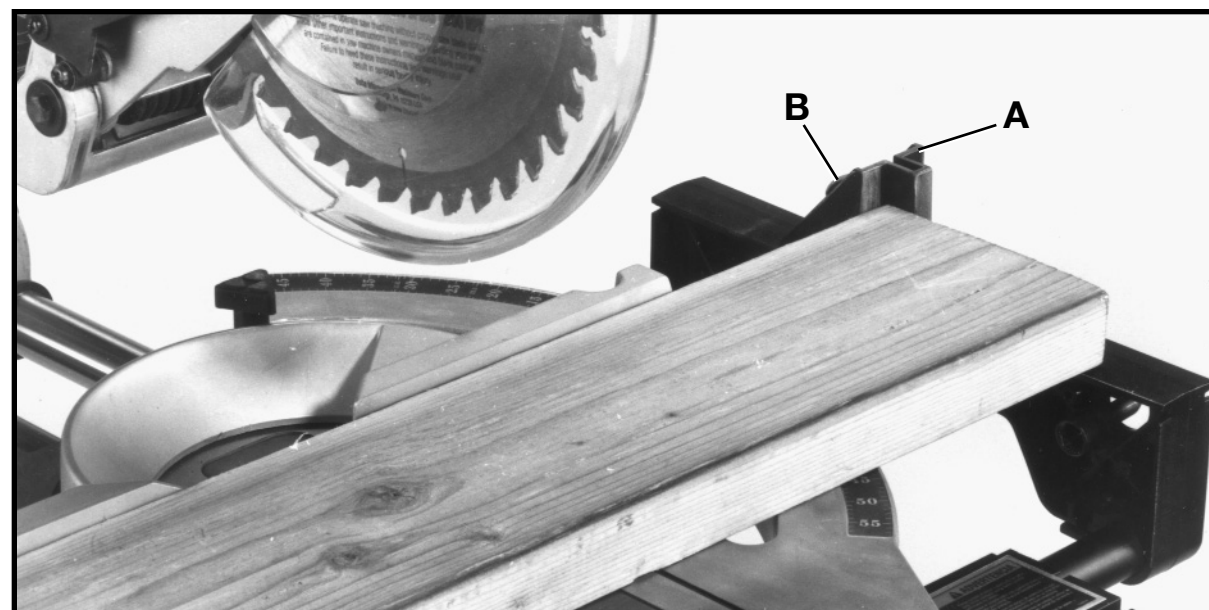

Fig. 54

The auxiliary fence (A) can be used as a cut-off gage or stock stop when cutting a number of pieces to the same length, as shown in Fig. 54. Loosen screw (B) and slide fence (A) forward to support and stop the workpiece. Then tighten screw (B).

FOLDING STAND FOR TRANSPORTATION

(FOR MODEL 36-250 ONLY)

1. Lock cuttinghead in the down and outward position. Rotate table to the 45 degree right angle position. Extension tables and fences should be pushed in toward the saw table and locked in place.

2. Loosen two locking knobs (G) Fig. 55. While holding legs (A), as shown, press spring-loaded detents (B) with your thumbs and carefully lower upper legs. Tighten locking knobs (G) Fig. 55.

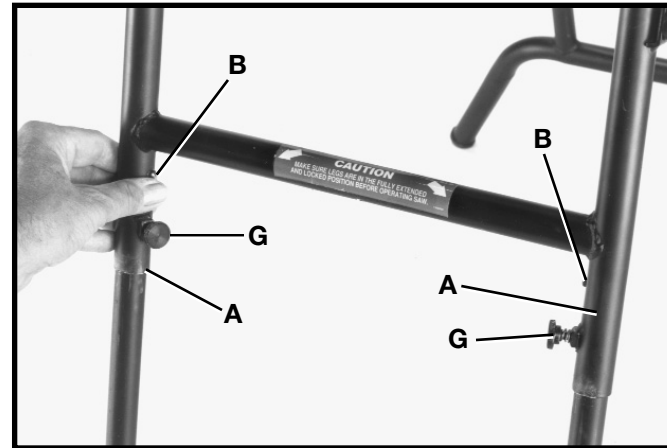

Fig. 55

3. Fig. 56, illustrates the left leg (C) lowered. Lower the right leg (D) in the same manner.

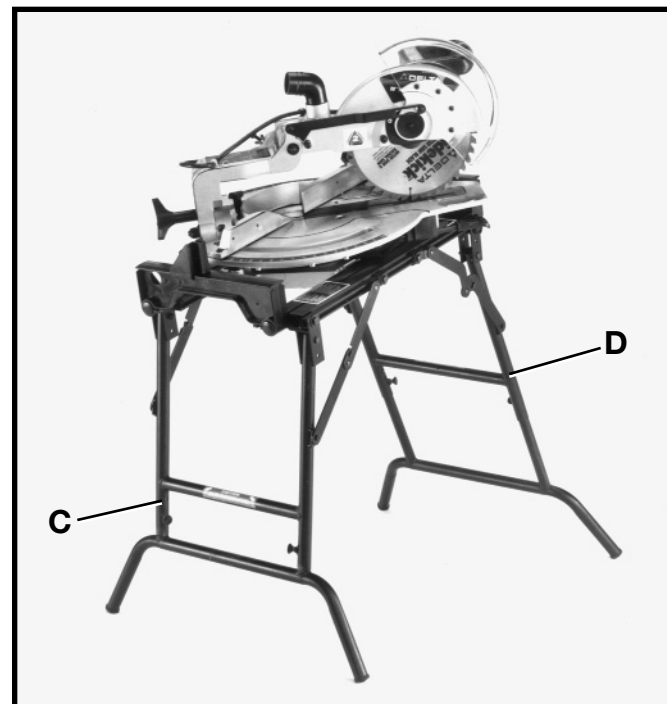

Fig. 56

4. Unlock hinges on left leg and fold left leg (C) in, as shown in Fig. 57.

5. Tilt machine on its side, as shown in Fig. 58, and continue to fold left leg (C) all the way underneath saw base. Leg (C) will contact and unlock hinges (E) of right leg (D), enabling right leg (D) to be folded.

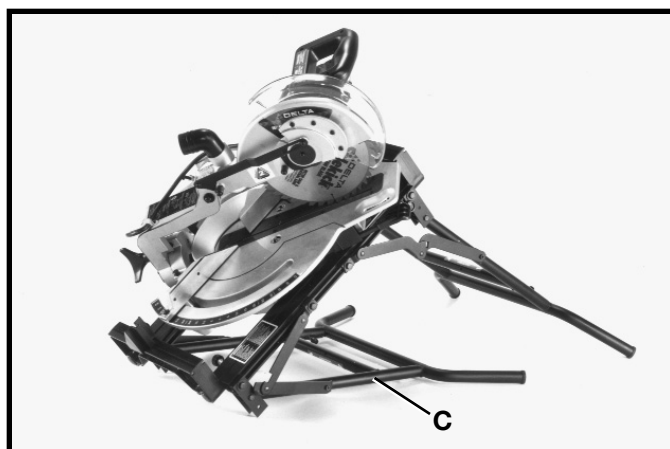

Fig. 57

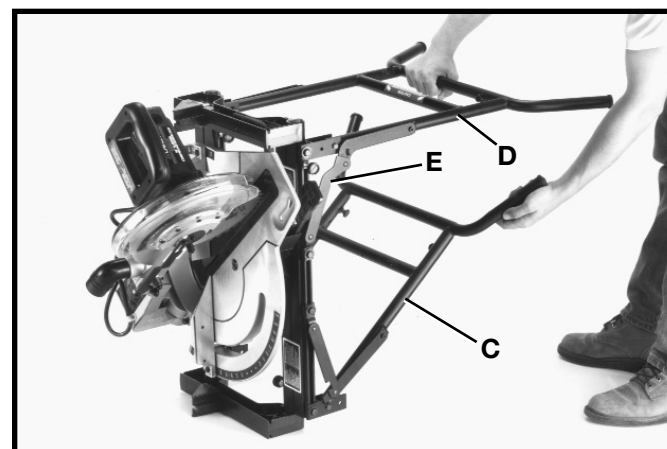

Fig. 58

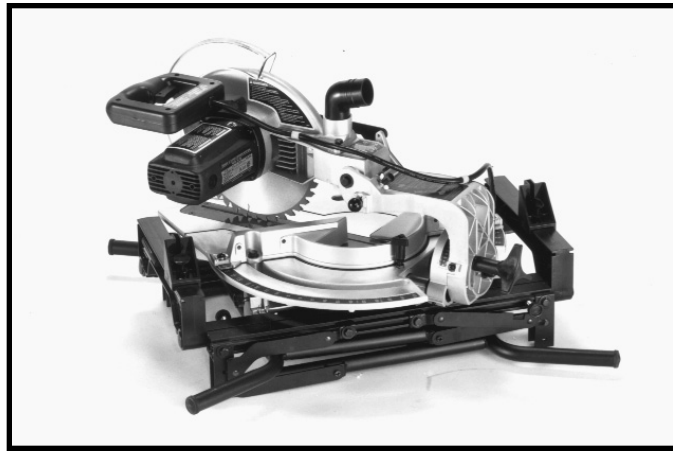

Fig. 59

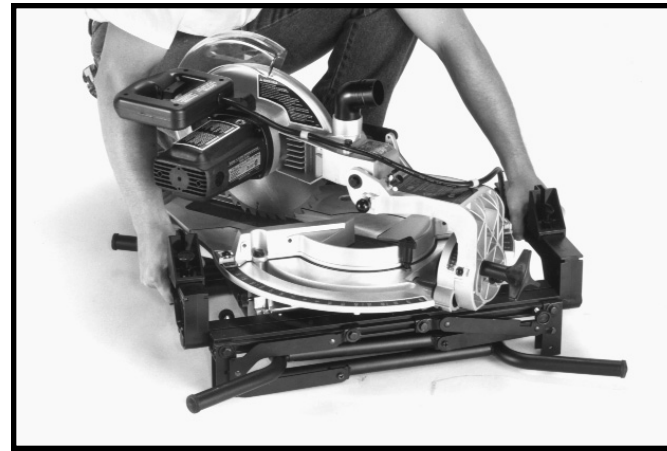

Fig. 60

6. Fig. 59, illustrates the stand in the folded position.
7. When moving the saw from place to place, lift saw by the two extension tables (F) as shown in Fig. 60.

REMOVING SAW FROM STAND (FOR MODEL 36-250 ONLY)

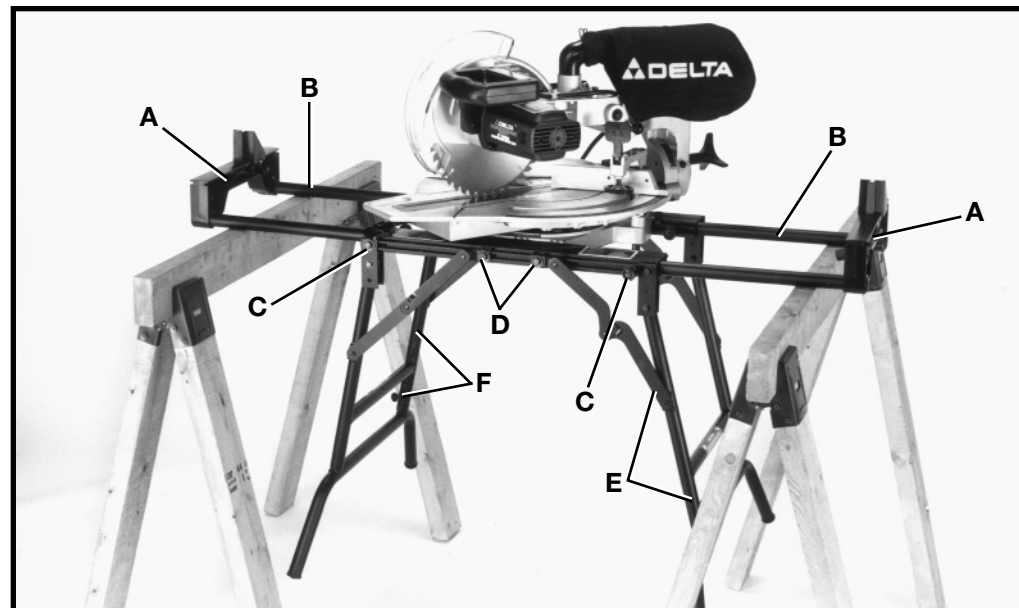

Fig. 61

If desired, your 10" compound slide saw can be removed from the stand in order to use the saw on a workbench; on saw horses; or on 2 x 4 table extensions. To remove the saw from the stand, proceed as follows:

1. Pull out extension tables (A) Fig. 61, and lock in place.
2. Position extension arms (B) on two saw horses, as shown, or other suitable supports, making sure legs of stand are above floor surface.
3. Loosen two screws (C) Fig. 61, and remove screws (D) Fig. 61, as shown. Repeat these instructions for the rear of the stand.
4. Slide leg assembly (E) Fig. 61, off the saw base to the right and leg assembly (F) off the saw base to the left.

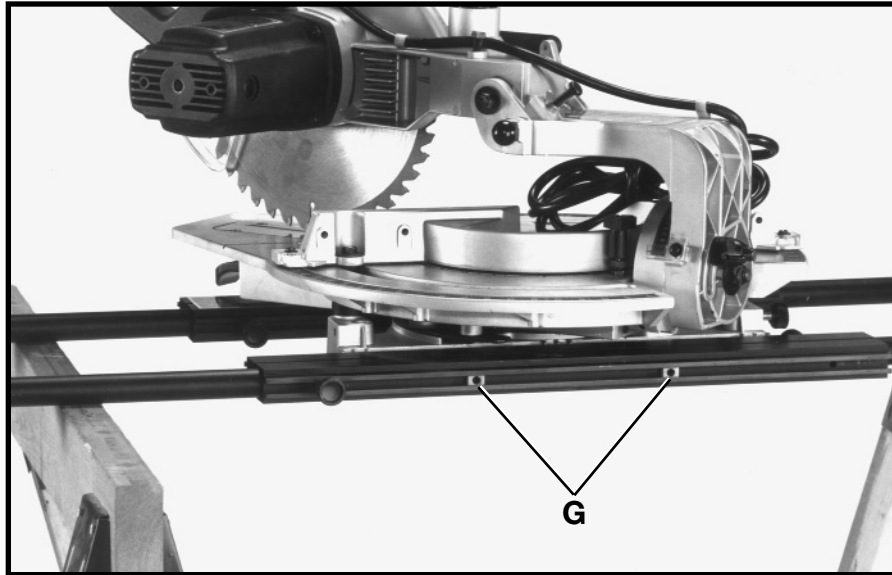

Fig. 62

5. Slide the two nuts (G) Fig. 62, out of the channel to the right. The two nuts remaining in the front channel must be removed in the same manner.

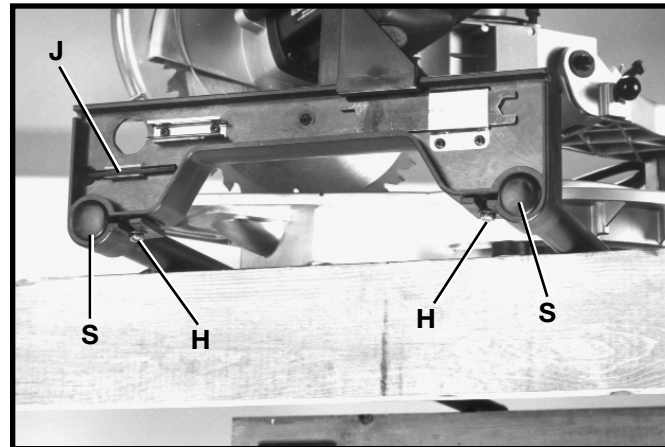

Fig. 63

6. Loosen two screws (H) Fig. 63, and slide table extension assembly (J) off rods (S). Remove table extension from other end of saw in the same manner.

7. Assemble the four mounting feet to the bottom channels of the saw as follows:

8. When using the saw on a workbench (See Fig. 68), assemble the mounting feet (K) to the channels, as shown in Fig. 64, and tighten screws (L). Assemble the remaining two mounting feet to the other side of the machine in the same manner.

9. When using the saw on saw horses or 2 x 4 extensions (See Figures 70 and 71), assemble the mounting feet (M) to the channels as shown in Fig. 65, and tighten screws (N). Assemble the remaining two mounting feet to the other side of the machine in the same manner.

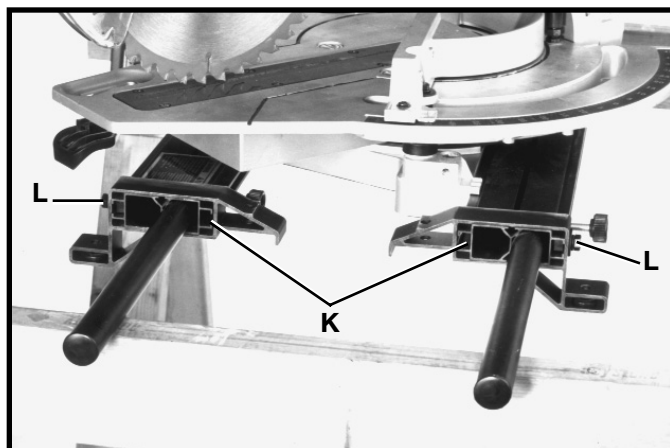

Fig. 64

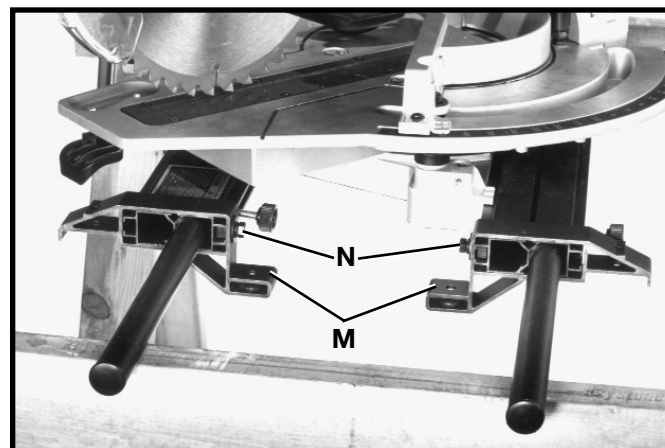

Fig. 65

10. If using the saw on a workbench (See Fig. 68) or on saw horses (See Fig. 70), re-assemble the two table extensions, one of which is shown at (J) Fig. 66, that were removed in **STEP 6**. If you are using the saw on 2 x 4 wooden extensions (See Fig. 71), push in the four table extension rods, two of which are shown at (O) Fig. 66, and lock in place. In this case it is not necessary to replace the table extensions (J).

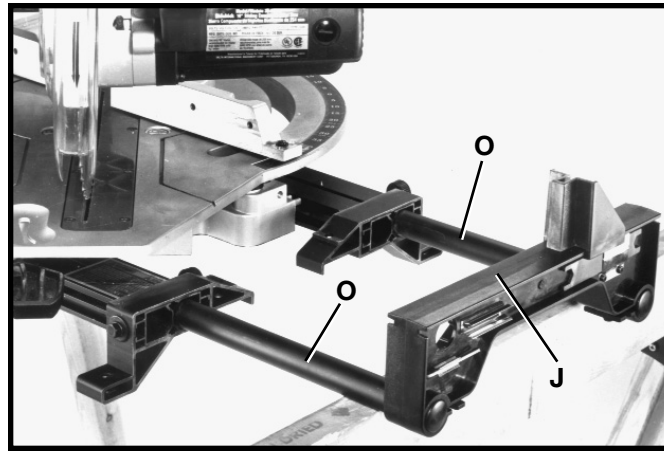

Fig. 66

FASTENING THE SAW TO A WORKBENCH (FOR ALL MODELS)

Figs. 67 and 68, illustrate the slide saw fastened to a workbench. Holes provided in the base of the units (A) Fig. 67 and (B) Fig. 68, are used to mount the machines to a supporting surface using standard hardware. **FOR MODEL 36-250 ONLY:** Please note that the table extensions and auxiliary fences (A) Fig. 68, can also be used.

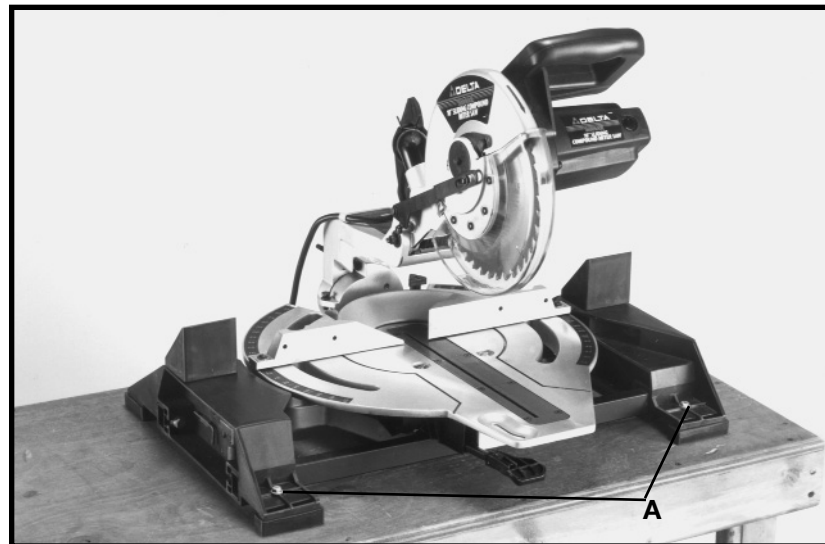

Fig. 67

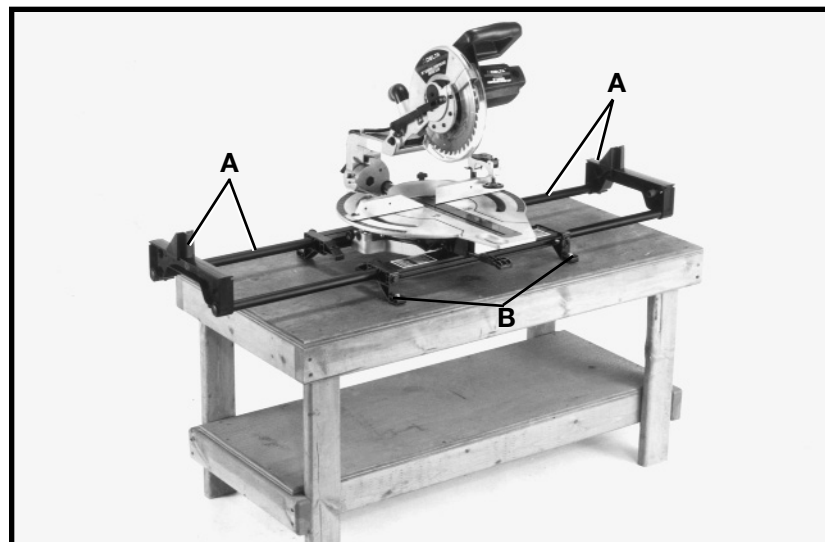

Fig. 68

USING THE SAW ON SAW HORSES

Figs. 69 and 70, illustrate the saw placed for use on saw horses. Notches in the front and rear of the mounting feet are designed to fit conveniently on saw horses. **FOR MODEL 36-250 ONLY:** Please note the table extensions and auxiliary fences (A) Fig. 70, can be used when operating the stand model on saw horses.



Fig. 69

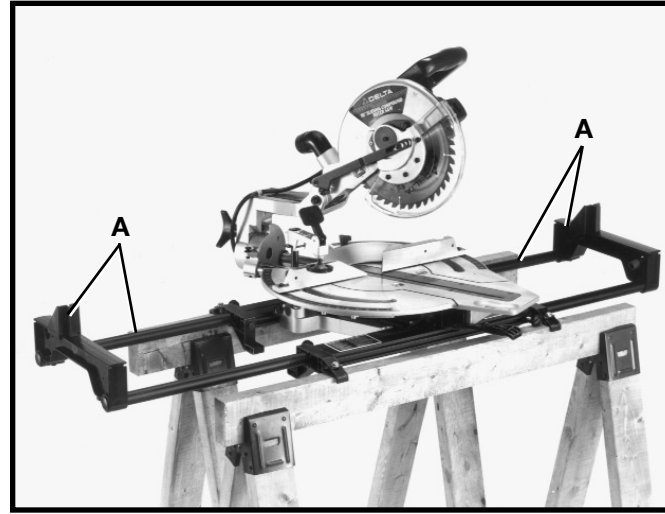

Fig. 70

USING SAW WITH 2 X 4 EXTENSIONS

1. Fig. 71 illustrates the saw being used with 2 x 4 extensions. Note that notches in the front and rear of the mounting feet (K) are designed to fit and fastened to the top of the two 2 x 4's (P). The length of the two 2 x 4's (P) can vary depending on your preference. The distance from the top of the 2 x 4's (P) to the saw table is 3-1/2". This enables you to nail or fasten standard 2 x 4's (R) to the 2 x 4's (P), as shown. The top of the 2 x 4's (R) will then be in alignment with the saw table, providing support for long work pieces. If desired, fence extensions (S) made of 2 x 2's can be aligned with fence (T) and bolted to 2 x 4's (R).

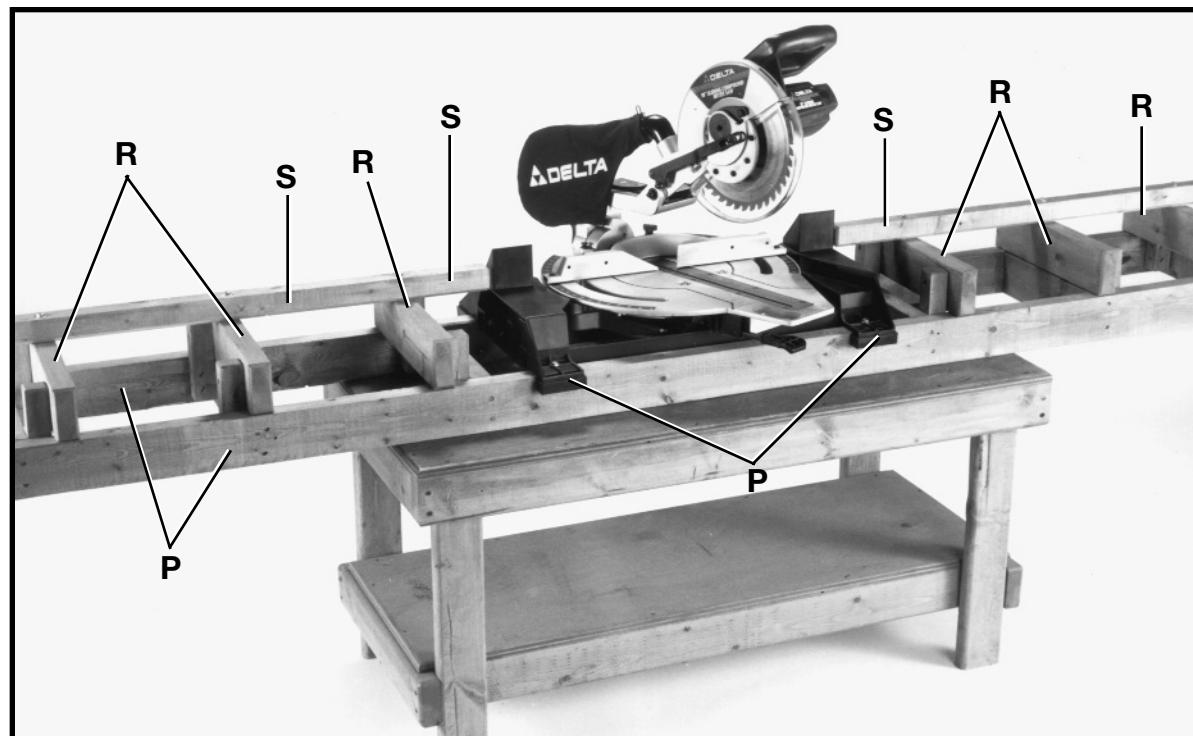

Fig. 71

REPLACING SAW ON STAND

(FOR MODEL 36-250 ONLY)

When assembling the stand to the saw, reverse the instructions listed in the section “**REMOVING SAW FROM STAND**” and keep in mind that the distance between the center of screw (A) Fig. 72, and bent hinge screw (B) **MUST BE 8”** and the distance between the center of screw (C) and straight hinge screw (D) **MUST BE 8-1/2”**.

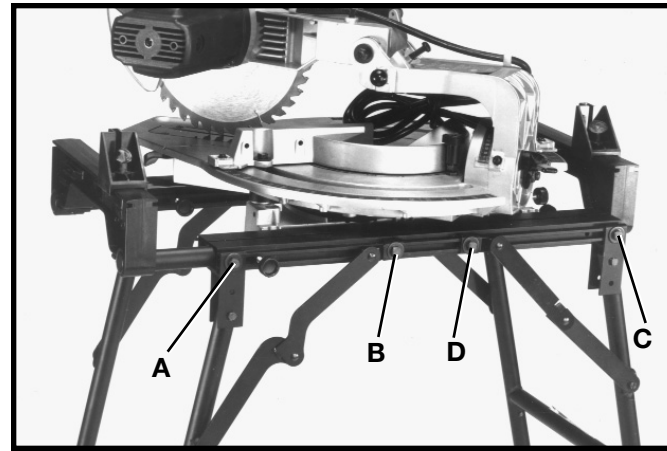



Fig. 72

OPERATION

CORRECT OPERATING PROCEDURE FOR SLIDE CUTTING

 **WARNING: SLIDE CUTTING BY PULLING THE SAW TOWARDS THE OPERATOR CAN BE DANGEROUS, CAUSING THE SAW TO KICK UPWARDS AND TOWARDS THE OPERATOR. ALWAYS PUSH THE SAW FORWARD, AWAY FROM THE OPERATOR, AND TOWARDS THE FENCE WHEN SLIDE CUTTING.** The following steps illustrate the proper operating procedure to follow when slide cutting with your compound slide saw. **NOTE:** Operational illustrations are shown using the slide saw on a work bench using 2 x 4 extensions.

1. Place the workpiece (A) on the table and against the fence, as shown in Fig. 73. Grasp the cuttinghead handle (B) but do not turn the saw on at this time.

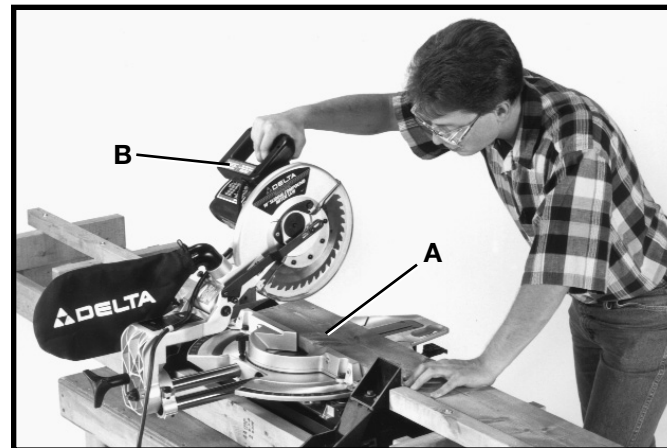

Fig. 73

2. Pull the cuttinghead (C) Fig. 74, toward you, with the cuttinghead in the up position. After the cuttinghead is pulled toward you, compress switch trigger to turn the saw on, as shown.

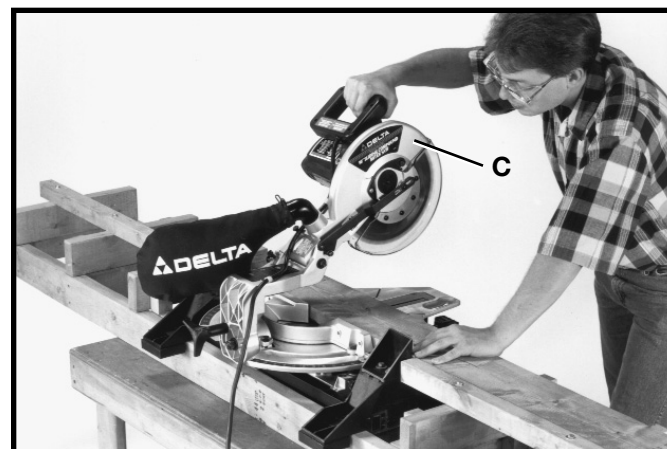

Fig. 74

3. Push down on the cuttinghead (C) Fig. 75, with the blade running, as shown.

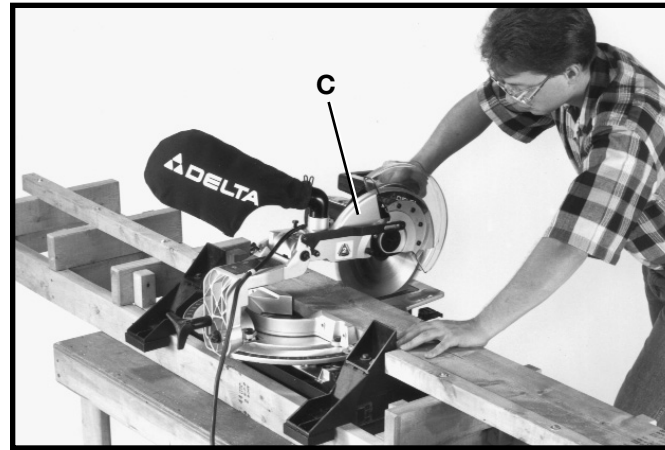

Fig. 75

4. Push the cuttinghead (C) Fig. 76, forward toward the fence, making the cut as shown.



Fig. 76

5. Figure 77 illustrates the completed cut. Release the switch trigger and keep the cuttinghead in the down position until the blade (D) comes to a complete stop.

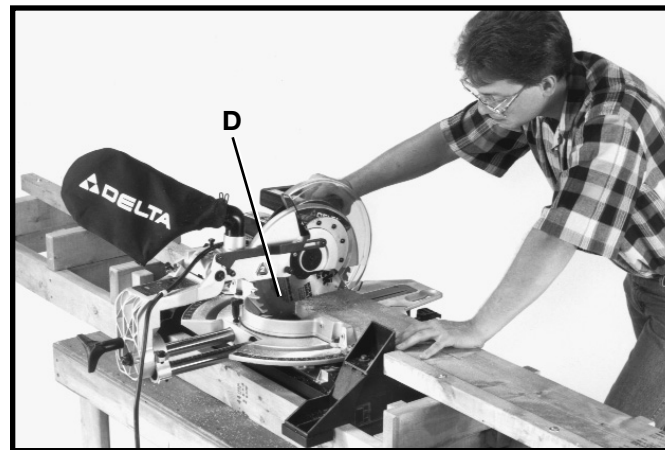

Fig. 77

6. After the blade has stopped, raise the cuttinghead (C) to the up position, as shown in Fig. 78.

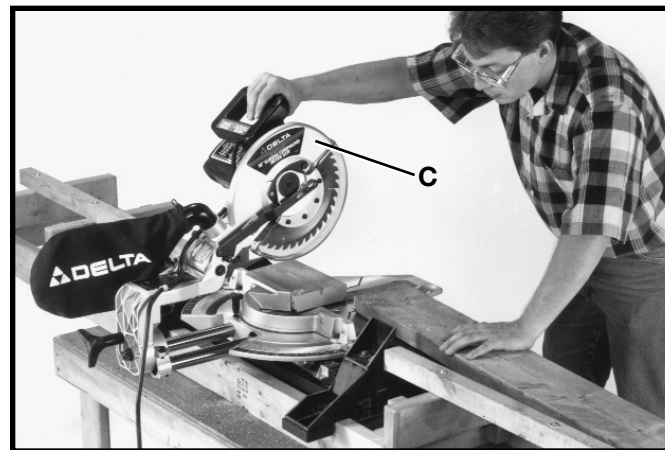

Fig. 78

USING THE WORK CLAMP AND STOCK STOP

Figures 79 and 80 illustrate a compound miter/bevel cut being made using the work clamp (A), which is used to firmly hold the work against the table, and the auxiliary fence (B), which has been adjusted to be used as a stock stop. **IMPORTANT:** When the work clamp (A) is used in conjunction with the stock stop (B) Fig. 80, should **ALWAYS** be on the same side of the saw blade. This is important as it prevents the free end of the workpiece from binding between the blade and the stock stop.

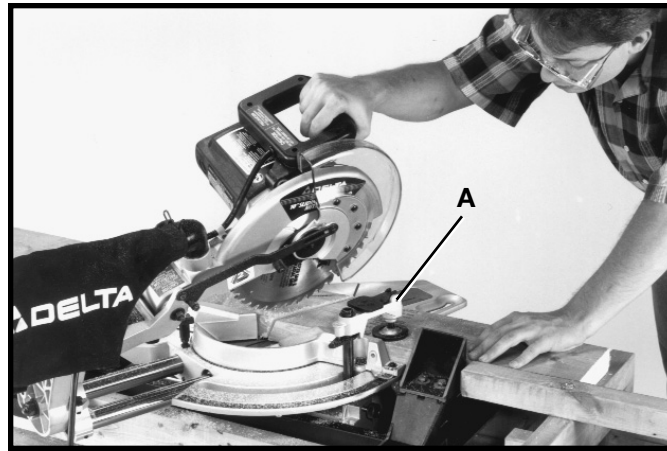

Fig. 79

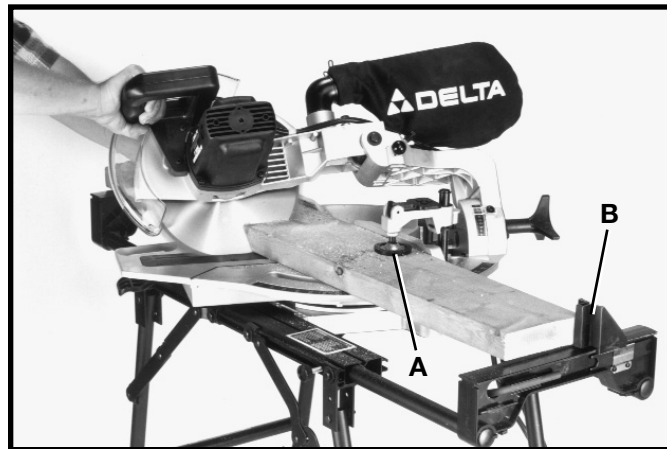

Fig. 80

USING SAW AS A CHOP SAW

The sliding action of the saw must be locked in the rear position, as shown in Fig. 81, by tightening lock knob (A), when cutting material that is narrow enough to allow the saw blade to cut through in a chopping motion. The cuttinghead (B) is pushed straight down to make the cut. After the cut is completed, release the switch trigger and let the blade come to a complete stop before returning the cuttinghead to the up position.

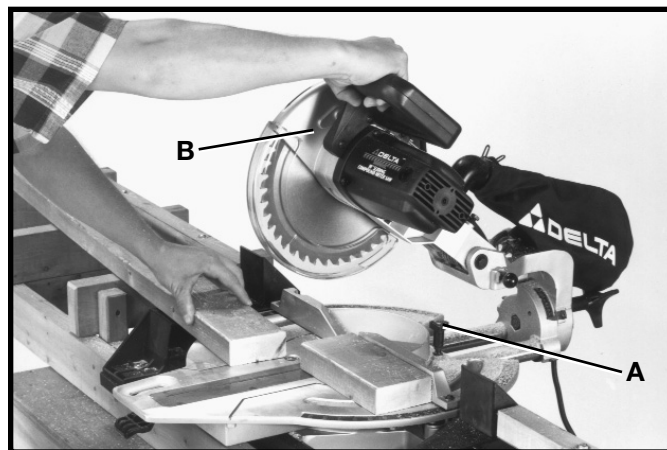

Fig. 81

DADO CUTTING

Dado cutting can easily be accomplished with your compound slide saw, as shown in Fig. 82, using a single saw blade and moving the workpiece sideways the width of the saw blade after each cut. The cut is made in the conventional way as explained in the section “**CORRECT OPERATING PROCEDURE**” and the downward travel of the saw blade is adjusted for the depth of the dado as explained in the section “**ADJUSTING DOWNWARD TRAVEL OF SAW BLADE**”.



Fig. 82

CUTTING CROWN MOULDING

One of the unique features of your saw is the ease of cutting crown moulding. The following is an example of cutting both inside and outside corners on 52/38 degree wall angle crown moulding. **NOTE:** When cutting 45 degree wall angle crown moulding the following procedure for inside and outside corners is the same with the exception that the bevel position will always be at 30 degrees and the miter position will be 35-1/4 degrees to the right or left.

1. Set the rotating table to the 31.62 degree right miter position, as shown in Fig. 83. A positive stop is provided to set the rotating table at this angle quickly. Tilt the saw blade to the 33.9 degree bevel position. An indicator is provided on the bevel scale to find this angle quickly.

2. Place the crown moulding on the saw table with the **CEILING EDGE** of the moulding against the fence, as shown in Fig. 83, and make the cut. Note that we are using the work clamp (A) Fig. 83, to hold the workpiece firmly against the table. The piece of crown moulding used for the outside corner will always be on the right hand side of the blade, as shown at (B) Fig. 83. The piece of crown moulding used for the inside corner will always be on the left side of the blade, as shown at (C) Fig. 83.

3. To make the matching halves of the inside and outside corners, set the rotating table to the 31.62 degree left miter position, as shown in Fig. 84. A positive stop is provided to set the rotating table at this angle quickly. The saw blade is already tilted to the 33.9 degree bevel angle from the previous cut.

4. Place the crown moulding on the saw table with the **WALL EDGE** of the crown moulding against the fence, as shown in Fig. 84, and make the cut. Again, note that we are using the work clamp (A) Fig. 84, to hold the workpiece firmly against the table. The piece of crown moulding used for the outside corner will always be on the right side of the blade, as shown at (D) Fig. 84. The piece of crown moulding used for the inside corner will always be on the left side of the blade, as shown at (E) Fig. 84.

5. Fig. 85, illustrates the two outside corner pieces, (B) being the piece cut at (B) Fig. 83; and (D) being the piece cut at (D) Fig. 84.

6. Fig. 86, illustrates the two inside corner pieces, (C) being the piece cut at (C) Fig. 83; and (E) being the piece cut at (E) Fig. 84.

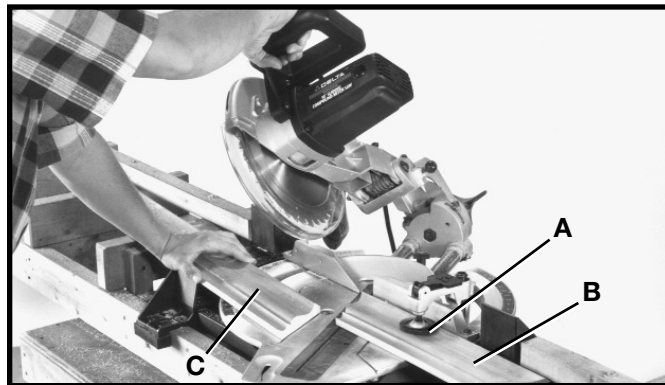

Fig. 83

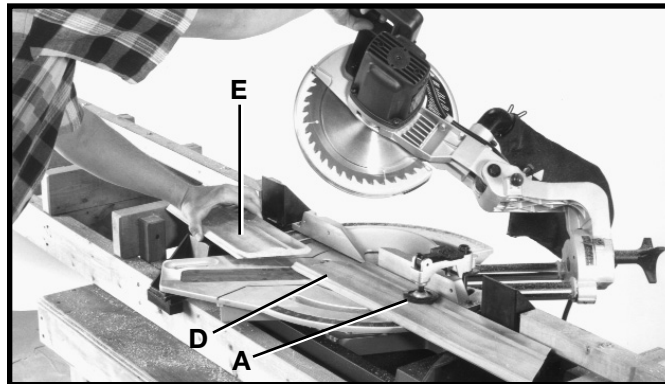

Fig. 84

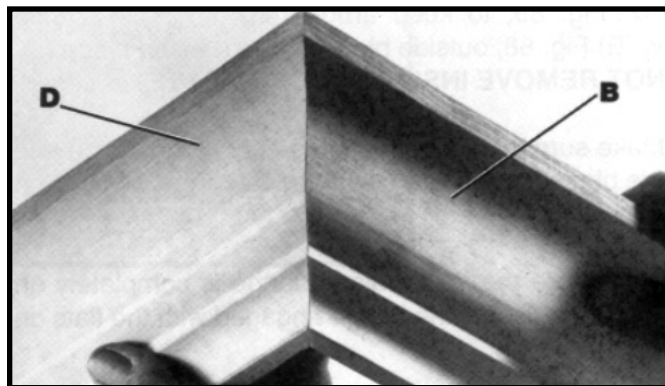

Fig. 85

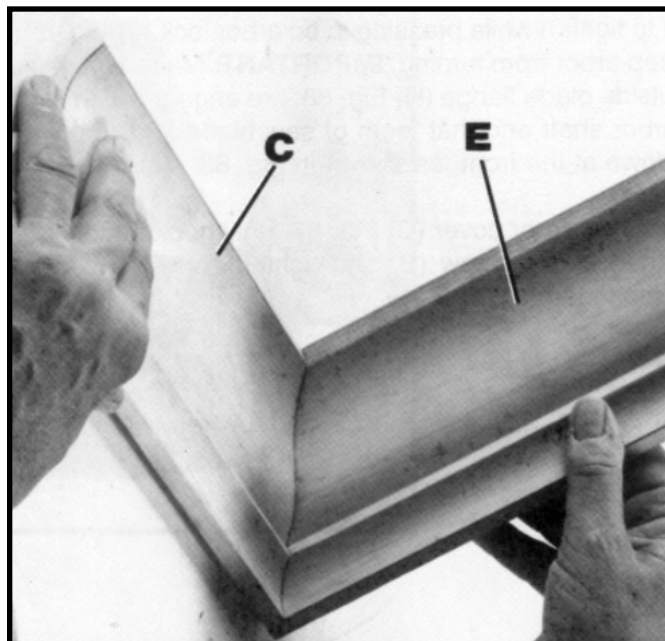



Fig. 86

MAINTENANCE

CHANGING THE BLADE

 **WARNING: USE ONLY CROSSCUT SAW BLADES. WHEN USING CARBIDE TIPPED BLADES, MAKE SURE THEY HAVE A ZERO DEGREE OR NEGATIVE HOOK ANGLE. DO NOT USE BLADES WITH DEEP GULLETS AS THEY CAN DEFLECT AND CONTACT GUARD. USE ONLY BLADES RATED FOR OPERATION OF AT LEAST 5000 RPM WITH 5/8" ARBOR HOLES.**

1. **DISCONNECT THE TOOL FROM THE POWER SOURCE.**

2. Using the special wrench (A) Fig. 87, supplied, loosen screw (B) to free arbor cover (C).

3. Rotate arbor cover (C) Fig. 88, and lower guard (D) to the up position, as shown.

4. Remove arbor screw (E) Fig. 88, by turning screw (E) clockwise while at the same time pressing in on arbor lock (F) Fig. 89, to keep arbor from turning. Remove screw (E) Fig. 88, outside blade flange (H) and blade (J). **DO NOT REMOVE INSIDE BLADE FLANGE.**

5. Make sure the inside surfaces of both the inside and outside blade flanges are clean and free from any foreign substance.

6. Make sure the inside blade flange is completely on arbor with the flats in the flange engaged with the flats on the arbor.

7. Install new blade (J) Fig. 88, outside blade flange (H) and arbor screw (E). Turn arbor screw (E) counterclockwise to tighten while pressing in on arbor lock (F) Fig. 89, to keep arbor from turning. **IMPORTANT:** Make sure flats in outside blade flange (H) Fig. 88, are engaged with flats on arbor shaft and that teeth of saw blade (J) are pointing down at the front, as shown in Fig. 88.

8. Rotate arbor cover (C) Fig. 87, until hook in cover is engaged under screw (B) and tighten screw (B) which was loosened in **STEP 2**.

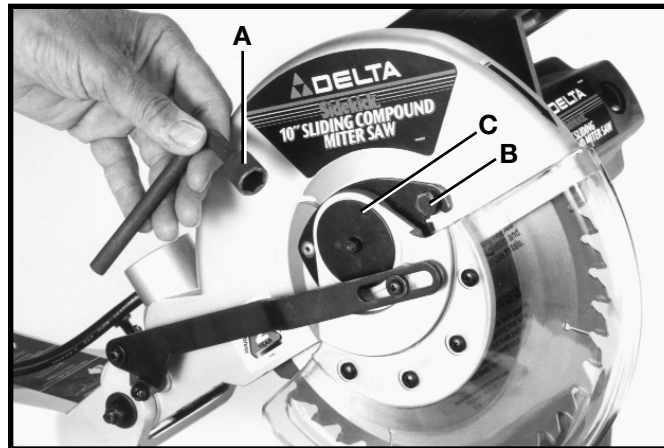

Fig. 87

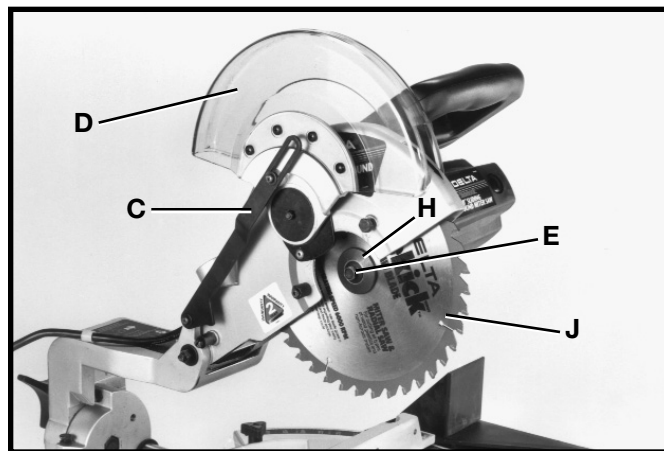

Fig. 88



Fig. 89

BRUSH INSPECTION AND REPLACEMENT

CAUTION: DISCONNECT THE TOOL FROM THE POWER SOURCE.

Brush life varies. It depends on the load on the motor. Check the brushes after the first 50 hours of use for a new machine or after a new set of brushes has been installed.

After the first check, examine them after about 10 hours of use until such time that replacement is necessary.

The brush holders (A) Fig. 90, are located on the motor housing opposite each other. Fig. 91, illustrates one of the brushes (B) removed for inspection. When the carbon on either brush is worn to $3/16$ " in length or if either spring or shunt wire is burned or damaged in any way, replace both brushes. If the brushes are found serviceable after removing, reinstall them in the same position as removed.



Fig. 90



Fig. 91

ACCESSORIES

A complete line of accessories is available from your Delta Supplier, Porter-Cable • Delta Factory Service Centers, and Delta Authorized Service Stations. Please visit our Web Site www.deltamachinery.com for a catalog or for the name of your nearest supplier.



WARNING: Since accessories, other than those offered by Delta, have not been tested with this product, use of such accessories could be hazardous. For safest operation, only Delta recommended accessories should be used with this product.

35-613 Saw Blade

50-325 Padlock



PARTS, SERVICE OR WARRANTY ASSISTANCE

All Delta Machines and accessories are manufactured to high quality standards and are serviced by a network of Porter-Cable • Delta Factory Service Centers and Delta Authorized Service Stations. To obtain additional information regarding your Delta quality product or to obtain parts, service, warranty assistance, or the location of the nearest service outlet, please call 1-800-223-7278 (In Canada call 1-800-463-3582).



Delta Building Trades and Home Shop Machinery Two Year Limited Warranty

Delta will repair or replace, at its expense and at its option, any Delta machine, machine part, or machine accessory which in normal use has proven to be defective in workmanship or material, provided that the customer returns the product prepaid to a Delta factory service center or authorized service station with proof of purchase of the product within two years and provides Delta with reasonable opportunity to verify the alleged defect by inspection. Delta may require that electric motors be returned prepaid to a motor manufacturer's authorized station for inspection and repair or replacement. Delta will not be responsible for any asserted defect which has resulted from normal wear, misuse, abuse or repair or alteration made or specifically authorized by anyone other than an authorized Delta Service facility or representative. Under no circumstances will Delta be liable for incidental or consequential damages resulting from defective products. This warranty is Delta's sole warranty and sets forth the customer's exclusive remedy, with respect to defective products; all other warranties, express or implied, whether of merchantability, fitness for purpose, or otherwise, are expressly disclaimed by Delta.

Printed in U.S.A.

NOTES

**PORTER-CABLE • DELTA SERVICE CENTERS
(CENTROS DE SERVICIO DE PORTER-CABLE • DELTA)**

Parts and Repair Service for Porter-Cable/Delta Power Tools are Available at These Locations
(Obtenga Refaccion de Partes o Servicio para su Herramienta en los Siguietes Centros de Porter-Cable•Delta)

ARIZONA

Tempe 85282 (Phoenix)
2400 West Southern Avenue
Suite 105
Phone: (602) 437-1200
Fax: (602) 437-2200

CALIFORNIA

Ontario 91761 (Los Angeles)
3949A East Guasti Road
Phone: (909) 390-5555
Fax: (909) 390-5554

San Leandro 94577 (Oakland)
3039 Teagarden Street
Phone: (510) 357-9762
Fax: (510) 357-7939

FLORIDA

Davie 33314 (Miami)
4343 South State Rd. 7 (441)
Unit #107
Phone: (954) 321-6635
Fax: (954) 321-6638

Tampa 33609
4538 W. Kennedy Boulevard
Phone: (813) 877-9585
Fax: (813) 289-7948

GEORGIA

Forest Park 30297 (Atlanta)
5442 Frontage Road,
Suite 112
Phone: (404) 608-0006
Fax: (404) 608-1123

ILLINOIS

Addison 60101 (Chicago)
311 Laura Drive
Phone: (630) 628-6100
Fax: (630) 628-0023

Woodridge 60517 (Chicago)
2033 West 75th Street
Phone: (630) 910-9200
Fax: (630) 910-0360

MARYLAND

Elkridge 21075 (Baltimore)
7397-102 Washington Blvd.
Phone: (410) 799-9394
Fax: (410) 799-9398

MASSACHUSETTS

Braintree 02185 (Boston)
719 Granite Street
Phone: (781) 848-9810
Fax: (781) 848-6759

Franklin 02038 (Boston)
Franklin Industrial Park
101E Constitution Blvd.
Phone: (508) 520-8802
Fax: (508) 528-8089

MICHIGAN

Madison Heights 48071 (Detroit)
30475 Stephenson Highway
Phone: (248) 597-5000
Fax: (248) 597-5004

MINNESOTA

Minneapolis 55429
4315 68th Avenue North
Phone: (763) 561-9080
Fax: (763) 561-0653

MISSOURI

North Kansas City 64116
1141 Swift Avenue
P.O. Box 12393
Phone: (816) 221-2070
Fax: (816) 221-2897

NEW YORK

Flushing 11365-1595 (N.Y.C.)
175-25 Horace Harding Expwy.
Phone: (718) 225-2040
Fax: (718) 423-9619

NORTH CAROLINA

Charlotte 28270
9129 Monroe Road, Suite 115
Phone: (704) 841-1176
Fax: (704) 708-4625

OHIO

Columbus 43214
4560 Indianola Avenue
Phone: (614) 263-0929
Fax: (614) 263-1238

OREGON

Cleveland 44125
8001 Sweet Valley Drive
Unit #19
Phone: (216) 447-9030
Fax: (216) 447-3097

OREGON

Portland 97230
4916 NE 122 nd Ave.
Phone: (503) 252-0107
Fax: (503) 252-2123

PENNSYLVANIA

Willow Grove 19090
520 North York Road
Phone: (215) 658-1430
Fax: (215) 658-1433

TEXAS

Carrollton 75006 (Dallas)
1300 Interstate 35 N, Suite 112
Phone: (972) 446-2996
Fax: (972) 446-8157

HOUSTON

Houston 77055
West 10 Business Center
1008 Wirt Road, Suite 120
Phone: (713) 682-0334
Fax: (713) 682-4867

WASHINGTON

Renton 98055 (Seattle)
268 Southwest 43rd Street
Phone: (425) 251-6680
Fax: (425) 251-9337

Authorized Service Stations are located in many large cities. Telephone **800-487-8665** or **731-541-6042** for assistance locating one. Parts and accessories for Porter-Cable•Delta products should be obtained by contacting any Porter-Cable•Delta Distributor, Authorized Service Center, or Porter-Cable•Delta Factory Service Center. If you do not have access to any of these, call **888-848-5175** and you will be directed to the nearest Porter-Cable•Delta Factory Service Center. Las Estaciones de Servicio Autorizadas están ubicadas en muchas grandes ciudades. Llame al **800-487-8665** ó al **731-541-6042** para obtener asistencia a fin de localizar una. Las piezas y los accesorios para los productos Porter-Cable•Delta deben obtenerse poniéndose en contacto con cualquier distribuidor Porter-Cable•Delta, Centro de Servicio Autorizado o Centro de Servicio de Fábrica Porter-Cable•Delta. Si no tiene acceso a ninguna de estas opciones, llame al **888-848-5175** y le dirigirán al Centro de Servicio de Fábrica Porter-Cable•Delta más cercano.

CANADIAN PORTER-CABLE • DELTA SERVICE CENTERS

ALBERTA

Bay 6, 2520-23rd St. N.E.
Calgary, Alberta
T2E 8L2
Phone: (403) 735-6166
Fax: (403) 735-6144

BRITISH COLUMBIA

8520 Baxter Place
Burnaby, B.C.
V5A 4T8
Phone: (604) 420-0102
Fax: (604) 420-3522

MANITOBA

1699 Dublin Avenue
Winnipeg, Manitoba
R3H 0H2
Phone: (204) 633-9259
Fax: (204) 632-1976

ONTARIO

505 Southgate Drive
Guelph, Ontario
N1H 6M7
Phone: (519) 836-2840
Fax: (519) 767-4131

QUÉBEC

1515 Avenue
St-Jean Baptiste
Québec, Québec
G2E 5E2
Phone: (418) 877-7112
Fax: (418) 877-7123

1447, Begin
St-Laurent, (Montréal), Québec
H4R 1V8
Phone: (514) 336-8772
Fax: (514) 336-3505

The following are trademarks of PORTER-CABLE•DELTA (Las siguientes son marcas registradas de PORTER-CABLE S.A.): BAMMER®, INNOVATION THAT WORKS®, JETSTREAM®, LASERLOC®, OMNIJIG®, POCKET CUTTER®, PORTA-BAND®, PORTA-PLANE®, PORTER-CABLE®, QUICKSAND®, SANDTRAP®, SAW BOSS®, SPEED-BLOC®, SPEEDMATIC®, SPEEDTRONIC®, STAIR-EASE®, THE PROFESSIONAL EDGE®, THE PROFESSIONAL SELECT®, TIGER CUB®, TIGER SAW®, TORQBUSTER®, WHISPER SERIES®, DURATRONIC™, FLEX™, FRAME SAW™, MICRO-SET™, MORTEN™, NETWORK™, RIPTIDE™, TRU-MATCH™, WOODWORKER'S CHOICE™.

Trademarks noted with ® are registered in the United States Patent and Trademark Office and may also be registered in other countries. Las Marcas Registradas con el signo de ® son registradas por la Oficina de Registros y Patentes de los Estados Unidos y también pueden estar registradas en otros países.